



X3



X5



X10



X20



X20 Suppressor



ATAC



ATAC Suppressor



X50



Stoeger Owner's Manual

Stoeger® AIRGUNS



Stoeger Airguns
is a Beretta Group brand.

www.stoegerairguns.com

Owner's Manual

X3 - X5 - X10 - X20 - X20 SUPPRESSOR - ATAC - ATAC SUPPRESSOR - X50

Calibers: .177 (4,5mm) .22 (5,5mm) .25 (6,35mm) Spring Air Rifles

US SECTION 3**INTERNATIONAL SECTION**

<input type="checkbox"/> English / English	16
<input type="checkbox"/> Spanish / Español.....	24
<input type="checkbox"/> Italian / Italiano.....	32
<input type="checkbox"/> French / Français	40
<input type="checkbox"/> German / Deutsch	48
<input type="checkbox"/> Russian / Русский	56
<input type="checkbox"/> Greek / Ελληνικά	64
<input type="checkbox"/> Portuguese / Português	72
<input type="checkbox"/> Finnish / Suomi.....	80
<input type="checkbox"/> Swedish / Svensk	88
<input type="checkbox"/> Turkish / Türkçe	96

ILLUSTRATIONS 104

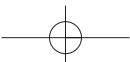
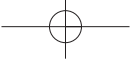

OWNER'S MANUAL

IMPORTANT: US customers have to refer to the "USA Section" of this Owner's Manual



Stoeger AIRGUNS

READ ALL INSTRUCTIONS AND WARNINGS IN THIS MANUAL BEFORE USING THIS AIRGUN.

Congratulations and thank you for purchasing your new STOEGER pellet airgun.

WARNING

THIS AIRGUN IS NOT A TOY. THIS AIRGUN IS TO BE USED BY ADULTS ONLY.

PLEASE READ THIS OWNER'S MANUAL COMPLETELY. ALWAYS TREAT YOUR AIRGUN AS YOU WOULD A REAL FIREARM.

WARNING

FOLLOW THIS OWNER'S MANUAL SAFETY INSTRUCTIONS CAREFULLY AND KEEP THIS MANUAL SAFELY FOR FUTURE USE. DO NOT SELL YOUR AIRGUN WITHOUT THIS OWNER MANUAL.

OWNER AND USER MUST KNOW AND OBEY ALL LOCAL LAWS ABOUT THE OWNERSHIP AND THE USE OF THIS AIRGUN.

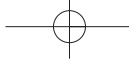

CONTENTS

USA

1	Airgun parts	9
2	Safety handling	10
3	Adjusting the trigger	10
4	Cocking	10
5	Loading	11
6	Shooting: aiming and firing	11
7	Airgun maintenance	11
8	Service and Repairs.....	12

Manual subject to modification without prior notice.

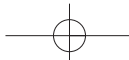

AIRGUN SAFETY

1. NEVER POINT AN AIRGUN AT SOMETHING THAT IS NOT SAFE TO SHOOT.

Never let the muzzle of an airgun point at any part of your body or at another person. This is especially important when loading or unloading the airgun.

When you are shooting at a target, know what is behind it.

If you miss your target or if the pellet penetrates the target, it is your responsibility to ensure that the shot does not cause unintended injury or damage.



2. AN AIRGUN CAN CAUSE PERMANENT INJURY OR DEATH. ALWAYS TREAT AN AIRGUN AS A REAL FIREARM AND AS IF IT WAS LOADED.

Never assume that an airgun is unloaded. **The only certain way to ensure that an airgun is**

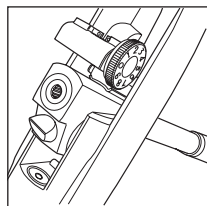

not loaded is to open the barrel and visually examine the inside to see if a pellet is present.

3. STORE YOUR AIRGUN SO THAT CHILDREN CANNOT GAIN ACCESS TO IT.

It is your responsibility to ensure that children under the lawful age of possession of an airgun or other unauthorized persons do not gain unsupervised access to your airgun.

To reduce the risk of accidents involving children, unload your airgun, lock it and store the pellets in a separate locked location.

Please note that devices intended to prevent accidents - for example, cable locks, trigger locks, etc. - may not prevent use or misuse of your airgun by a determined person. Steel gun safes may be more appropriate to reduce the likelihood of intentional misuse of an airgun by an unauthorized child or person.

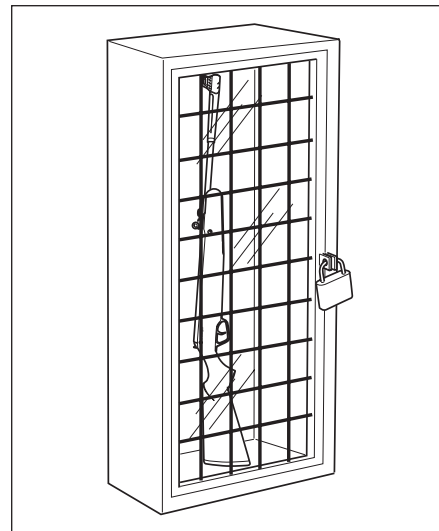

4. NEVER SHOOT AT WATER OR AT A HARD SURFACE.

Shooting at the surface of water or at a rock or other hard surface increases the chance of ricochets or fragmentation of the pellet, which can result in the projectile striking an unintended or peripheral target.



5. KNOW THE SAFETY FEATURES OF THE AIRGUN YOU ARE USING, BUT REMEMBER: SAFETY DEVICES ARE NOT A SUBSTITUTE FOR SAFE HANDLING PROCEDURES.

Keep your airgun on "safe" until ready to fire, but never rely solely on a safety device to prevent an accident. It is imperative that you know and use the safety features of the particular airgun you are handling, but accidents can best be prevented by following the safe handling procedures described in these safety rules and elsewhere in the product manual.

To further familiarize yourself with the proper use of airguns, take an airgun Safety Course taught by an expert in airgun use and safety procedures.

6. PROPERLY MAINTAIN YOUR AIRGUN.

Store and carry your airgun so that dirt or lint does not accumulate in the working parts. Clean and oil your airgun, following the instructions provided your user's manual, after each use to prevent corrosion, damage to the barrel or accumulation of impurities.

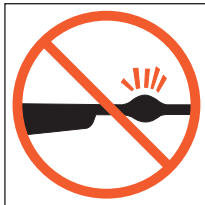

Always check the barrel prior to loading to ensure that it is clean and free from obstructions. **Firing against an obstruction can cause a dangerous build up of pressure and might injure yourself or others nearby.** If you hear an unusual noise when shooting, stop firing immediately, engage the manual safety and unload the airgun. Make sure the barrel is free from any obstruction.

7. USE PROPER PELLETS.

Be certain that each pellet you use is in the proper caliber for the airgun. The caliber of the airgun is clearly marked on the barrel of the airgun. The use of low quality pellets may affect the accuracy or obstruct the barrel by accumulation of pellets inside the barrel.

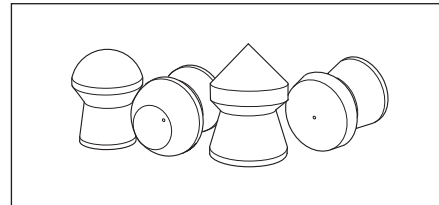

USA

8. ALWAYS WEAR PROTECTIVE GLASSES WHEN SHOOTING.

A pellet or pellet fragments can blow back or ricochet and cause serious injury including the possible loss of eyesight. The shooter and bystanders must always wear impact resistant shooting glasses when firing any airgun.

**9. NEVER CLIMB A TREE, FENCE OR OBSTRUCTION WITH A LOADED AIRGUN.**

Open barrel before climbing or descending a tree or before climbing a fence or jumping over a ditch or obstruction. Never pull or push a loaded airgun toward yourself or another person.

**10. AVOID ALCOHOLIC BEVERAGES AND JUDGMENT OR REFLEX IMPAIRING MEDICATION WHEN SHOOTING.**

Do not drink and shoot. If you take medication that can impair motor reactions or judgment, do not handle an airgun while you are under the influence of the medication.

**11. NEVER TRANSPORT A LOADED AIRGUN.**

Unload an airgun before putting it in a vehicle. Hunters and target shooters should load their airgun only at their destination.

**12. NEVER FIRE YOUR AIRGUNS WITHOUT PELLETS IN THE BARREL.**

This may permanently damage your rifle.

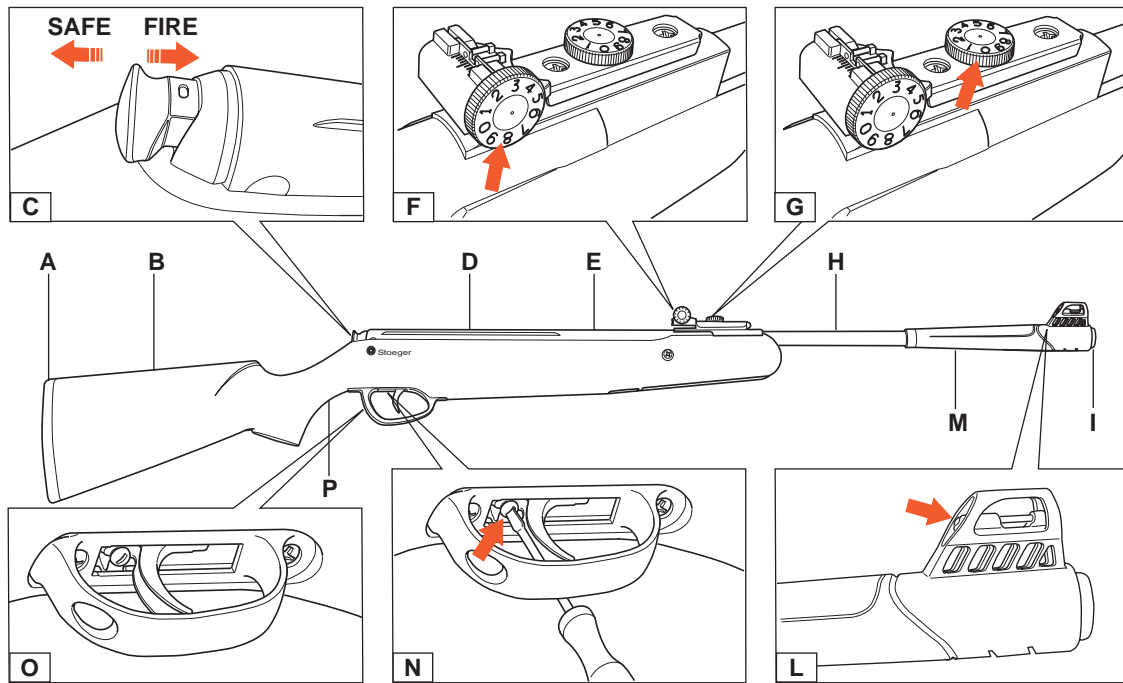

1 AIRGUN PARTS

- A Butt pad
- B Stock
- C Safety
- D Rail for scope mount

- E Compression cylinder
- F Windage adjustment screw
- G Elevation adjustment screw
- H Barrel
- I Muzzle

- L Front sight with fiber optic
- M Grip
- N Trigger adjustment screw
- O Trigger guard
- P Pistol grip

2 SAFETY HANDLING

Your airgun has an automatic locking safety which engages automatically when you cock your gun. The safety slide is situated at the end of the compression tube (**fig. C**):

- Back = safe
Safety button fully rearward - white dot visible - the safety is in the "ON" or "Safe" position
- Forward = fire
Push the safety button fully forward - white dot not visible - to put the safety in the "OFF" or "Fire" position.

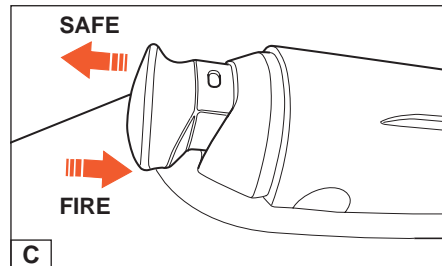

3 ADJUSTING THE TRIGGER

Trigger pull is adjusted in the factory, and does not need adjustment for most shooters. This two stage trigger has an adjusting screw for second stage length adjustment (**fig. N**).

This feature is for experienced shooters on models X10, X20, X20 Suppressor, Atac, Atac Suppressor and X50.

- To reduce second stage length, turn screw clockwise.
- To increase second stage length, turn screw counter clockwise.

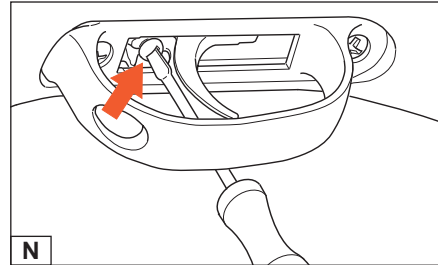

4 COCKING

Point the airgun in safe direction while keeping your finger off the trigger (**fig. Q**).

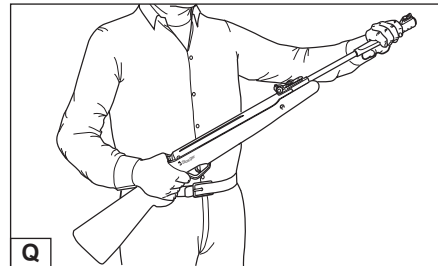

With one hand grasp stock at the pistol grip. Holding the rifle firmly, **tap barrel behind front sight** in order to break locked position (**fig. R**).

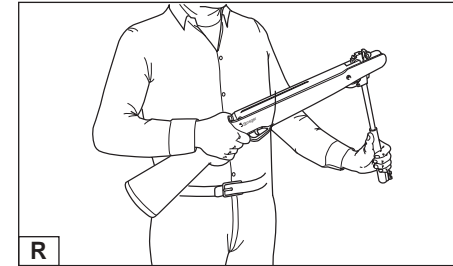

Grasp barrel behind the front sight and pull downward until it stops. You will hear an audible click of the trigger mechanism lock when the pressure is released. You must control, and not release, the barrel under strong resistance until the audible click is heard. Be careful not to pinch your hand or fingers in the hinge area (**fig. S**).

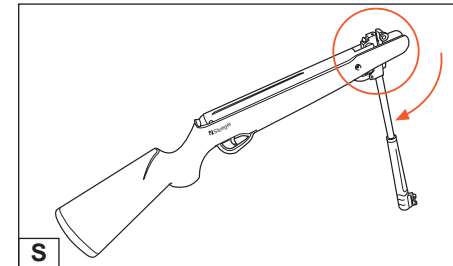

5 LOADING

Check pellet to ensure it matches the caliber of the airgun. Insert pellet into the barrel until skirt is flush with breech face (**fig. T**).

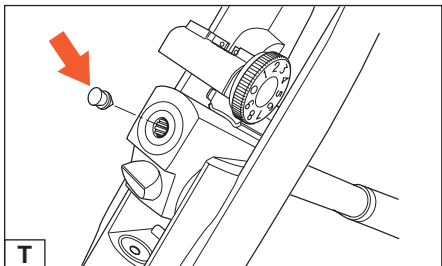

Move barrel back to its original locked position.

Again, be careful not to pinch your hand or fingers in the hinge area (**fig. U**).

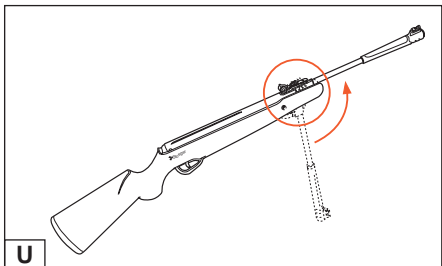

6 SHOOTING: AIMING AND FIRING

Keep finger outside trigger guard until on target, push safety button fully forward, squeeze trigger. Safety can be put back to "On" or "Safe" positions at any time by pulling fully rewarded (white dot visible).

A) Wrong (**fig. V**)

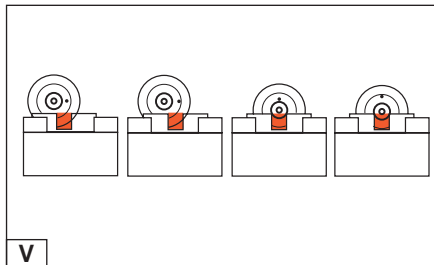

B) Right (**fig. Z**)

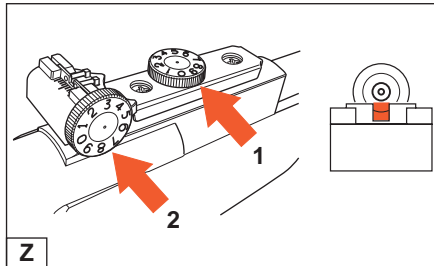

Your airgun is equipped with an adjustable rear sight for both elevation (1) (up-down) and windage (left-right) (2).

Elevation settings are marked on the elevation knob and controlled by turning elevation screw 1.

- Turn clockwise to make the airgun shoot lower
- Turn counter clockwise to make the airgun shoot higher

Left or Right windage settings are marked on the sliding scale and controlled by turning windage screw 2.

- Turn clockwise to make the pellet hit to the right
- Turn counter clockwise to make the pellet hit to the left

The scale and numbers are for reference only, and do not represent a specific distance at the target.

7 AIRGUN MAINTENANCE

Airgun care requires very little cleaning and maintenance.

Mechanicals parts:

Barrel should be cleaned before storage or at least after 500 shots with a cleaning rod (avoid brass brushes for rifling preservation), or cleaning pellets to be fired as a real pellet. You can apply a drop of gun oil into the barrel.

Every 1000 shots, apply a drop of gun lubricant into the compression chamber (fig. W).

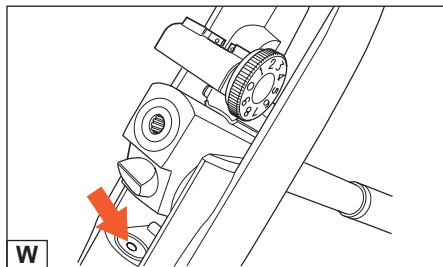

Blued parts as barrel and compression cylinder should be protected from rusting. Maintain protection by wiping these parts with a lightly oiled pad.

All visible mechanicals parts, breach, trigger, safety may be lightly oiled as needed to maintain a proper function.

Stock care:

Synthetic stocks require no maintenance except wiping clean and drying with a soft cloth or towel. Wooden stocks should only be stored at room temperature because excessive heat can crack them. A wooden stock can be polished with oil and a soft cloth.

Storage:

- Do not leave the rifle in the cocked position, as this weakens the mainspring.
- Decock your airgun by firing in a safe direction and always strictly respect all safety rules.
- Do not leave the rifle in humid environment.

WARNING

- **Do not attempt to disassemble your airgun. Take or send it to an authorized service station.**
- **Do not modify your airgun, handling it in a different manner as described in this manual, as this could make your gun unsafe and you will void the warranty.**
- **Any modification may make the gun unsafe to use, and cause serious injury or death.**
- **Do not fire the airgun without pellet in the barrel (dry fire) as this may damage you airgun permanently.**

8 SERVICE AND REPAIRS

Call STOEGER INDUSTRIES (301) 283 6300 and ask for the Service Department. It is possible that our Service personnel and gunsmiths will be able to help you over the phone.

In the event this is not possible, authorized service and repairs will be issued a RA (Return Authorization) Number. Write this number boldly on the box. Include a note in the box stating the defect or problem along with your name, address and phone number. Return prepaid to:

STOEGER INDUSTRIES

Airgun division
801 Broad Street
Pocomoke, MD 21851

Warranty Claims

All Stoeger Airguns carry a limited 2 year warranty.

Stoeger Industries to You - This new Stoeger Airgun is warranted only to the original retail purchaser, for two years from the date of purchase. This warranty applies only if the product was purchased from an authorized Stoeger reseller in United States.

Stoeger will at its option, repair or replace without charge any product fails due to a defect in workmanship or materials. Parts and labor are included. Repairs are warranted for the duration of the original warranty. If Stoeger replaces an airgun under its original warranty, you will receive a new two year warranty. Stoeger will return replacement airgun to you freight prepaid.

To Obtain Warranty Service - You must send your airgun freight prepaid to Stoeger Industries at the address listed above. No C.O.D. shipments will be accepted. Only the Stoeger reap facility in Maryland is authorized to make warranty repairs. **DO NOT PACK OR SHIP LOADED AIRGUNS.**

Return the complete unloaded airgun with a detailed description of the problem. You must provide Stoeger satisfactory proof of the date of original purchase if the warranty registration is not on file. Only a sales receipt or properly completed warranty registration card for a new Stoeger airgun will establish eligibility for warranty repairs when a product is returned. You must provide proof of the date you purchased a new Stoeger product at the time you send a product for warranty repair.

What is Not Covered - The warranty does not cover defects or damage caused by:

- 1) Misuse or accident
- 2) Failure to provide proper care and maintenance
- 3) Failure to comply with instructions in the owner's manual
- 4) Normal wear and tear
- 5) Rust or corrosion
- 6) Obstruction in the barrel.

All wooden parts are excluded from warranty repairs. This warranty does not cover claims made by the subsequent owner of any Stoeger product.

ANY UNAUTHORIZED ALTERATION OR MODIFICATION OF THE AIRGUN WILL VOID THE WARRANTY.

STOEGER SHALL NOT BE RESPONSIBLE FOR ANY CLAIMS INVOLVING AIRGUN THAT RESULT FROM THE USE OF NON STANDARD OR REUSED PELLETS.

IN NO EVENT SHALL STOEGER INDUSTRIES BE LIABLE FOR CONSEQUENTIAL DAMAGES. Some states do not allow the exclusion or limitation of incidental or consequential damages, so the above limitation or exclusion may not apply to you. The warranty gives specific legal rights, and so you may also have other rights which vary from state to state.

Stoeger Industries authorizes no dealer or any other person to vary the terms of this warranty or make any other express warranties.

Where to get Further Help - If you have any questions concerning this warranty, please contact:

- Stoeger Industries (301) 283-6300 or
- Stoeger Industries
17603 Indian Head Highway,
Accocheek, MD 20607-2501.

USA

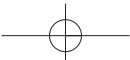
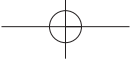



Stoeger AIRGUNS

OWNERS' MANUAL

GB

USO Y MANTENIMIENTO

E

USO E MANUTENZIONE

I

MODE D'EMPLOI ET D'ENTRETIEN

F

VERWENDUNG UND WARTUNG

D

ЭКСПЛУАТАЦИЯ И ТЕХОБСЛУЖИВАНИЕ

RUS

ΧΡΗΣΗ ΚΑΙ ΣΥΝΤΗΡΗΣΗ

GR

USO E MANUTENÇÃO

P

KÄYTTÖ- JA HUOLTO-OHJEET

FIN

ANVÄNDNING OCH UNDERHÅLL

S

KULLANIM VE BAKIM

TR

READ ALL INSTRUCTIONS AND WARNINGS IN THIS MANUAL BEFORE USING THIS AIRGUN.

Congratulations and thank you for purchasing your new STOEGER pellet airgun.

WARNING

THIS AIRGUN IS NOT A TOY. THIS AIRGUN IS TO BE USED BY ADULTS ONLY.

PLEASE READ THIS OWNER'S MANUAL COMPLETELY. ALWAYS TREAT YOUR AIRGUN AS YOU WOULD A REAL FIREARM.

WARNING

FOLLOW THIS OWNER'S MANUAL SAFETY INSTRUCTIONS CAREFULLY AND KEEP THIS MANUAL SAFELY FOR FUTURE USE. DO NOT SELL YOUR AIRGUN WITHOUT THIS OWNER MANUAL.

OWNER AND USER MUST KNOW AND OBEY ALL LOCAL LAWS ABOUT THE OWNERSHIP AND THE USE OF THIS AIRGUN.

CONTENTS

1	Airgun parts	21
2	Safety handling	22
3	Adjusting the trigger	22
4	Cocking	22
5	Loading	22
6	Shooting: aiming and firing	22
7	Airgun maintenance	23
8	Service and Repairs	23

GB

Manual subject to modification without prior notice.

AIRGUN SAFETY

1. NEVER POINT AN AIRGUN AT SOMETHING THAT IS NOT SAFE TO SHOOT.

Never let the muzzle of an airgun point at any part of your body or at another person. This is especially important when loading or unloading the airgun.

When you are shooting at a target, know what is behind it.

If you miss your target or if the pellet penetrates the target, it is your responsibility to ensure that the shot does not cause unintended injury or damage.



2. AN AIRGUN CAN CAUSE PERMANENT INJURY OR DEATH. ALWAYS TREAT AN AIRGUN AS A REAL FIREARM AND AS IF IT WAS LOADED.

Never assume that an airgun is unloaded. **The only certain way to ensure that an airgun is**

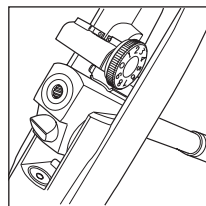

not loaded is to open the barrel and visually examine the inside to see if a pellet is present.

3. STORE YOUR AIRGUN SO THAT CHILDREN CANNOT GAIN ACCESS TO IT.

It is your responsibility to ensure that children under the lawful age of possession of an airgun or other unauthorized persons do not gain unsupervised access to your airgun.

To reduce the risk of accidents involving children, unload your airgun, lock it and store the pellets in a separate locked location.

Please note that devices intended to prevent accidents - for example, cable locks, trigger locks, etc. - may not prevent use or misuse of your airgun by a determined person. Steel gun safes may be more appropriate to reduce the likelihood of intentional misuse of an airgun by an unauthorized child or person.

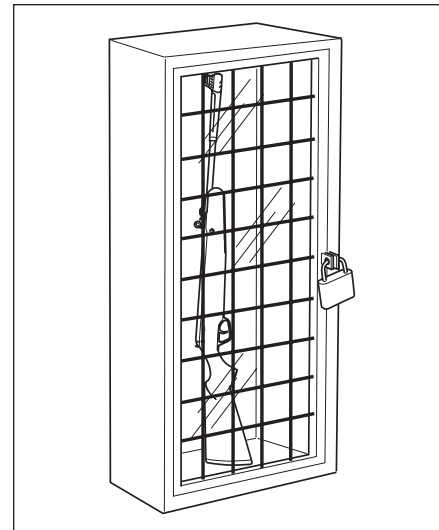

4. NEVER SHOOT AT WATER OR AT A HARD SURFACE.

Shooting at the surface of water or at a rock or other hard surface increases the chance of ricochets or fragmentation of the pellet, which can result in the projectile striking an unintended or peripheral target.

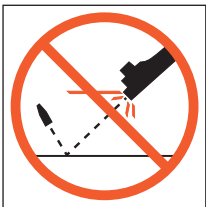

5. KNOW THE SAFETY FEATURES OF THE AIRGUN YOU ARE USING, BUT REMEMBER: SAFETY DEVICES ARE NOT A SUBSTITUTE FOR SAFE HANDLING PROCEDURES.

Keep your airgun on "safe" until ready to fire, but never rely solely on a safety device to prevent an accident. It is imperative that you know and use the safety features of the particular airgun you are handling, but accidents can best be prevented by following the safe handling procedures described in these safety rules and elsewhere in the product manual.

To further familiarize yourself with the proper use of airguns, take an airgun Safety Course taught by an expert in airgun use and safety procedures.

6. PROPERLY MAINTAIN YOUR AIRGUN.

Store and carry your airgun so that dirt or lint does not accumulate in the working parts. Clean and oil your airgun, following the instructions provided your user's manual, after each use to prevent corrosion, damage to the barrel or accumulation of impurities.

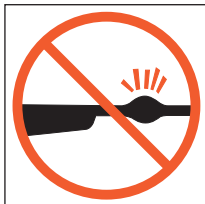

Always check the barrel prior to loading to ensure that it is clean and free from obstructions. **Firing against an obstruction can cause a dangerous build up of pressure and might injure yourself or others nearby.** If you hear an unusual noise when shooting, stop firing immediately, engage the manual safety and unload the airgun. Make sure the barrel is free from any obstruction.

7. USE PROPER PELLETS.

Be certain that each pellet you use is in the proper caliber for the airgun. The caliber of the airgun is clearly marked on the barrel of the airgun. The use of low quality pellets may affect the accuracy or obstruct the barrel by accumulation of pellets inside the barrel.

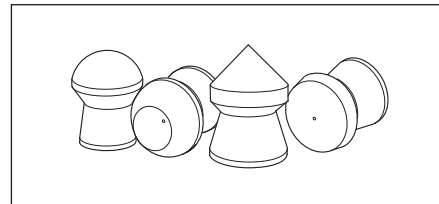

GB

8. ALWAYS WEAR PROTECTIVE GLASSES WHEN SHOOTING.

A pellet or pellet fragments can blow back or ricochet and cause serious injury including the possible loss of eyesight. The shooter and bystanders must always wear impact resistant shooting glasses when firing any airgun.

**10. AVOID ALCOHOLIC BEVERAGES AND JUDGMENT OR REFLEX IMPAIRING MEDICATION WHEN SHOOTING.**

Do not drink and shoot. If you take medication that can impair motor reactions or judgment, do not handle an airgun while you are under the influence of the medication.

**12. NEVER FIRE YOUR AIRGUNS WITHOUT PELLETS IN THE BARREL.**

This may permanently damage your rifle.

9. NEVER CLIMB A TREE, FENCE OR OBSTRUCTION WITH A LOADED AIRGUN.

Open barrel before climbing or descending a tree or before climbing a fence or jumping over a ditch or obstruction. Never pull or push a loaded airgun toward yourself or another person.

**11. NEVER TRANSPORT A LOADED AIRGUN.**

Unload an airgun before putting it in a vehicle. Hunters and target shooters should load their airgun only at their destination.



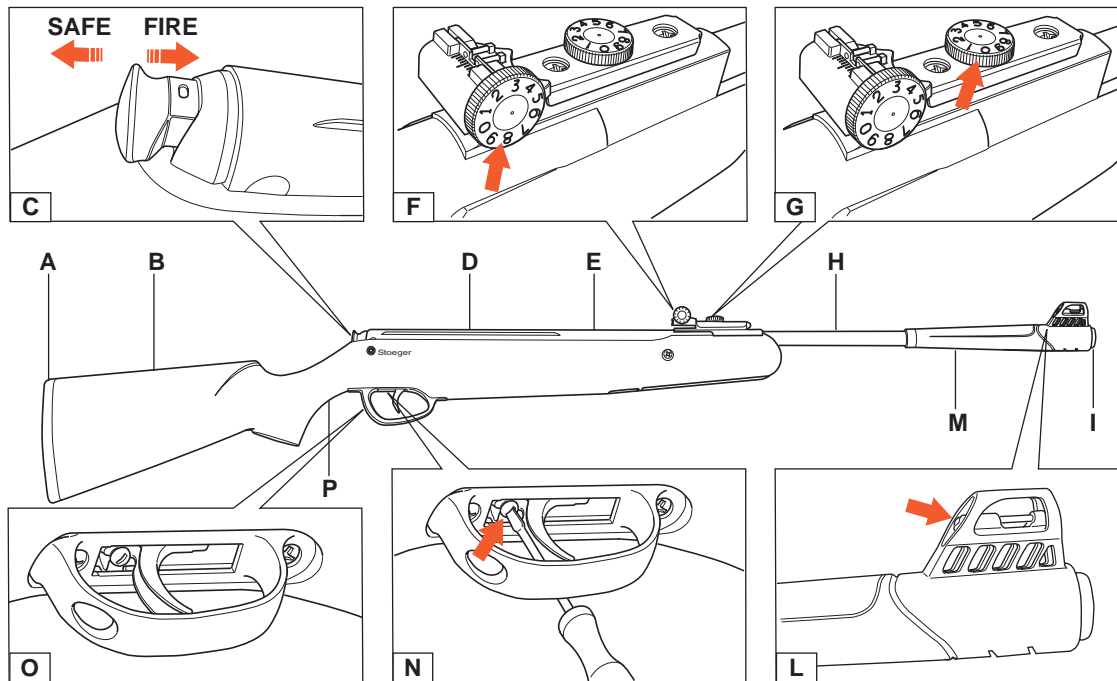

GB

1 AIRGUN PARTS

- A Butt pad
- B Stock
- C Safety
- D Rail for scope mount

- E Compression cylinder
- F Windage adjustment screw
- G Elevation adjustment screw
- H Barrel
- I Muzzle

- L Front sight with fiber optic
- M Grip
- N Trigger guard screw
- O Trigger guard
- P Pistol grip

2 SAFETY HANDLING

Your airgun has an automatic locking safety which engages automatically when you cock your gun. The safety slide is situated at the end of the compression tube (**fig. C**):

- Back = safe
Safety button fully rearward - white dot visible - the safety is in the "ON" or "Safe" position
- Forward = fire
Push the safety button fully forward - white dot not visible - to put the safety in the "OFF" or "Fire" position.

3 ADJUSTING THE TRIGGER

Trigger pull is adjusted in the factory, and does not need adjustment for most shooters.

This two stage trigger has an adjusting screw for second stage length adjustment (**fig. N**).

This feature is for experienced shooters on models X10, X20, X20 Suppressor, Atac, Atac Suppressor and X50.

- To reduce second stage length, turn screw clockwise.
- To increase second stage length, turn screw counter clockwise.

4 COCKING

Point the airgun in safe direction while keeping your finger off the trigger (**fig. Q**).

With one hand grasp stock at the pistol grip. Holding the rifle firmly, **tap barrel behind front sight** in order to break locked position (**fig. R**).

Grasp barrel behind the front sight and pull downward until it stops. You will hear an audible click of the trigger mechanism lock when the pressure is released. You must control, and not release, the barrel under strong resistance until the audible click is heard. Be careful not to pinch your hand or fingers in the hinge area (**fig. S**).

5 LOADING

Check pellet to ensure it matches the caliber of the airgun. Insert pellet into the barrel until skirt is flush with breech face (**fig. T**).

Move barrel back to its original locked position.

Again, be careful not to pinch your hand or fingers in the hinge area (**fig. U**).

6 SHOOTING: AIMING AND FIRING

Keep finger outside trigger guard until on target, push safety button fully forward, squeeze trigger. Safety can be put back to "On" or "Safe" positions at any time by pulling fully rewarded (white dot visible).

- Wrong (**fig. V**)
- Right (**fig. Z**)

Your airgun is equipped with an adjustable rear sight for both elevation (1) (up-down) and windage (left-right) (2).

Elevation settings are marked on the elevation knob and controlled by turning elevation screw 1.

- Turn clockwise to make the airgun shoot lower
- Turn counter clockwise to make the airgun shoot higher

Left or Right windage settings are marked on the sliding scale and controlled by turning windage screw 2.

- Turn clockwise to make the pellet hit to the right
- Turn counter clockwise to make the pellet hit to the left

The scale and numbers are for reference only, and do not represent a specific distance at the target.

7 AIRGUN MAINTENANCE

Airgun care requires very little cleaning and maintenance.

Mechanicals parts:

Barrel should be cleaned before storage or at least after 500 shots with a cleaning rod (avoid brass brushes for rifling preservation), or cleaning pellets to be fired as a real pellet. You can apply a drop of gun oil into the barrel.

Every 1000 shots, apply a drop of gun lubricant into the compression chamber (fig. W).

Blued parts as barrel and compression cylinder should be protected from rusting. Maintain protection by wiping these parts with a lightly oiled pad.

All visible mechanicals parts, breach, trigger, safety may be lightly oiled as needed to maintain a proper function.

Stock care:

Synthetic stocks require no maintenance except wiping clean and drying with a soft cloth or towel. Wooden stocks should only be stored at room temperature because excessive heat can crack them. A wooden stock can be polished with oil and a soft cloth.

Storage:

- Do not leave the rifle in the cocked position, as this weakens the mainspring.
- Decock your airgun by firing in a safe direction and always strictly respect all safety rules.
- Do not leave the rifle in humid environment.

WARNING

- **Do not attempt to disassemble your airgun. Take or send it to an authorized service station.**
- **Do not modify your airgun, handling it in a different manner as described in this manual, as this could make your gun unsafe and you will void the warranty.**
- **Any modification may make the gun unsafe to use, and cause serious injury or death.**
- **Do not fire the airgun without pellet in the barrel (dry fire) as this may damage you airgun permanently.**

8 SERVICE AND REPAIRS

Contact your dealer for first assistance or the official distributor in your country.

GB

The list of Official Distributors of the Stoeger Airguns products are available on: "stoegerairguns.com".

WARRANTY

All Stoeger Airguns are covered by a 2 years warranty valid from the purchase date.

Incidental damages, consequential damages to non-manual advices respect and non-authorized disassembling are excluding the airgun from the warranty.

What is not covered:

- Misuse or accident
- Failure to provide care and maintenance
- Failure to comply with instructions in the owner's manual
- Normal wear and tear
- Rust or corrosion
- Obstruction in the barrel

Wooden parts are excluded from warranty repairs. This warranty does not cover claims made by the subsequent owner of any Stoeger product.

LEA ATENTAMENTE TODOS LOS APARTADOS DE ESTE MANUAL ANTES DE UTILIZAR SU ESCOPETA DE AIRE COMPRIMIDO.

Enhorabuena y gracias por haber comprado su nueva escopeta de aire comprimido de balines STOEGER.

ATENCIÓN

ESTA ESCOPETA DE AIRE COMPRIMIDO NO ES UN JUGUETE. ESTA ESCOPETA DE AIRE COMPRIMIDO DEBE SER UTILIZADA SÓLO POR ADULTOS.

LEA ATENTAMENTE ESTE MANUAL DE INSTRUCCIONES POR COMPLETO. TRATE SIEMPRE SU ESCOPETA DE AIRE COMPRIMIDO COMO SI FUERA UN ARMA DE FUEGO REAL.

ATENCIÓN

SIGA ATENTAMENTE LAS INSTRUCCIONES PARA SU SEGURIDAD CONTENIDAS EN ESTE MANUAL DE INSTRUCCIONES Y GUARDE ESTE MANUAL EN UN LUGAR SEGURO PARA USOS FUTUROS. NO VENDA ESTA ESCOPETA DE AIRE COMPRIMIDO SIN ESTE MANUAL DE INSTRUCCIONES.

EL PROPIETARIO Y LOS USUARIOS TIENEN QUE RESPETAR RIGUROSAMENTE TODAS LAS LEYES LOCALES ACERCA DE LA PROPIEDAD Y DEL USO DE ESTA ESCOPETA DE AIRE COMPRIMIDO.

ÍNDICE

1	Partes de la escopeta de aire comprimido	29
2	Manejo seguro	30
3	Ajuste del gatillo	30
4	Montaje	30
5	Carga	30
6	Disparo: apuntar y disparar	30
7	Mantenimiento de la escopeta de aire comprimido	31
8	Asistencia y reparaciones	31

E

Manual sujeto a modificaciones sin previo aviso.

NORMAS RELATIVAS A LA SEGURIDAD DE LA ESCOPETA DE AIRE COMPRIMIDO

1. NO APUNTE NUNCA LA ESCOPETA DE AIRE COMPRIMIDO CONTRA ALGO A LO QUE PUEDA SER PELIGROSO DISPARAR.

No apunte nunca un arma hacia ninguna parte de su cuerpo o contra otra persona. Esto es importante sobre todo cuando se carga o descarga la escopeta de aire comprimido. Cuando se dispara a un blanco hay que controlar lo que hay detrás.

En el caso de que el objetivo no sea alcanzado o se sobrepase es su responsabilidad asegurarse de que el proyectil no cause lesiones o daños involuntarios a personas o cosas.



2. UNA ESCOPETA DE AIRE COMPRIMIDO PUEDE CAUSAR DAÑOS PERMANENTES O INCLUSO LA MUERTE. TRATE SIEMPRE LA ESCOPETA DE AIRE COMPRIMIDO COMO SI FUERA UN ARMA REAL Y ESTUVIERA CARGADA.

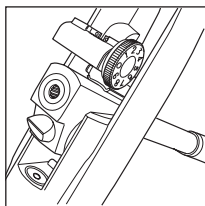

No presuma nunca de que la escopeta de aire comprimido está descargada. **La única manera de asegurarse de que una escopeta de aire comprimido está descargada es examinar el**

cañón y verificar que no quede dentro ningún balín.

3. MANTENGA LA ESCOPETA DE AIRE COMPRIMIDO FUERA DEL ALCANCE DE LOS NIÑOS.

Es responsabilidad del propietario de la escopeta de aire comprimido que los niños, menores de 18 años, o personas no autorizadas, no tengan acceso a ella si no están bajo la supervisión de personas autorizadas. **Para reducir el riesgo de incidentes en los que puedan verse envueltos los niños, descargue la escopeta de aire comprimido, guárdela bajo llave y coloque los balines en lugar separado, cerrado incluso con llave.**

Conviene tener presente que los sistemas empleados para prevenir incidentes, como por ejemplo asegurarla con candado o bloquear el gatillo, pueden a veces no impedir el uso o abuso intencionado de la escopeta de aire comprimido por parte de una persona determinada. Para evitar el mal uso intencionado de la escopeta de aire comprimido por parte de niños o personas no autorizadas se recomienda utilizar armarios blindados de seguridad.

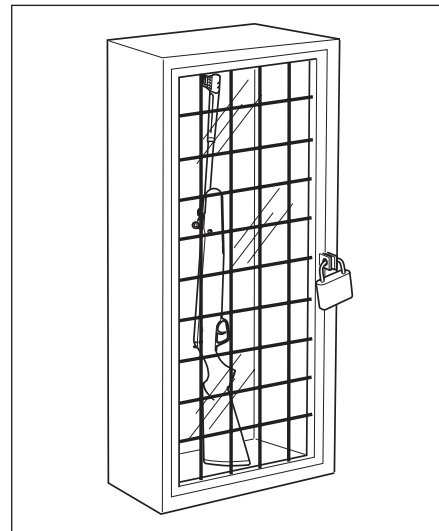

4. NO DISPARE NUNCA CONTRA EL AGUA O SUPERFICIES DURAS.

Disparar contra el agua o contra una roca u otra superficie dura aumenta la posibilidad de rebote o fragmentación de la bala o de los balines que podrían alcanzar un objetivo no intencionado o periférico.

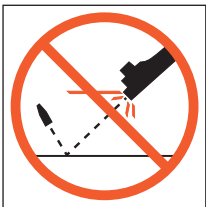

5. ASEGÚRESE DE CONOCER LOS DISPOSITIVOS DE SEGURIDAD DEL ARMA QUE ESTA USANDO: PERO RECUERDE QUE DICHS DISPOSITIVOS NO SUSTITUYEN A LAS NORMAS DE SEGURIDAD Y DE USO.

Mantenga su escopeta con el "seguro puesto" hasta que esté listo para disparar, sin embargo, no confíe sólo en los dispositivos de seguridad para prevenir los accidentes. Es imprescindible conocer y utilizar los dispositivos de seguridad específicos de la escopeta de aire comprimido que está manejando, aunque el mejor modo de prevenir dichos incidentes es seguir el procedimiento de uso de seguridad descrito en estas normas y que se encuentra en el interior del libro de instrucciones.

Para familiarizarse con el uso de ésta u otras escopetas de aire comprimido se aconseja seguir un curso de seguridad con las escopetas de aire comprimido impartido por expertos en esta materia.

6. REALICE UN MANTENIMIENTO ADECUADO DE LA ESCOPETA DE AIRE COMPRIMIDO.

Guarde y transporte la escopeta de aire comprimido de modo que no se acumule suciedad o pólvora en los mecanismos de funcionamiento. Limpie y lubrique la escopeta de aire comprimido, siguiendo las indicaciones de este manual, después de cada uso para prevenir: corrosión, daños en el cañón o acumulación de suciedad.

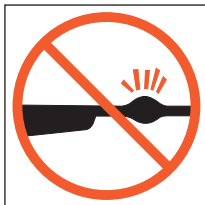

Compruebe siempre el cañón antes de cargar el arma para asegurarse que está limpio y libre de obstrucciones. **Disparar con obstrucciones en el cañón puede provocar un aumento de presión y causarle lesiones a usted mismo y a personas cercanas a usted,**

Si al disparar se produce algún sonido extraño deje automáticamente de disparar, ponga la escopeta de aire comprimido en posición segura y descárguela. Verifique que el cañón esté libre de obstrucciones.

7. USE LOS BALINES ADECUADOS.

Asegúrese de que cada balín que usa sea del calibre que su escopeta de aire comprimido requiere. El calibre de la escopeta de aire comprimido está estampado claramente en el cañón de la escopeta. El uso de balines de baja calidad podría afectar la precisión u obstruir el cañón con la acumulación de balines en su interior.

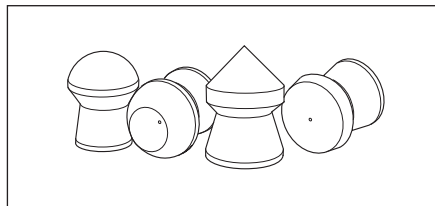

8. USE SIEMPRE GAFAS PROTECTORAS DURANTE EL TIRO.

Una bola o fragmentos de metal pueden salir disparados hacia atrás o rebotar provocando lesiones graves, incluida la pérdida de la vista. Cuando se dispara un arma el tirador y las personas presentes deben llevar siempre gafas protectoras y de una resistencia adecuada.



10. EVITE BEBIDAS ALCOHÓLICAS O MEDICAMENTOS QUE PUEDAN REDUCIR LA CAPACIDAD DE JUICIO Y SUS REFLEJOS DURANTE EL TIRO.

Evite beber alcohol antes de disparar. Si está tomando medicamentos que puedan disminuir su capacidad de juicio o sus reflejos, no use el arma mientras esté bajo el efecto de dichos medicamentos.



12. NUNCA DISPARE SU ESCOPETA DE AIRE COMPRIMIDO SIN BALINES EN EL CAÑÓN.

Esto podría dañar su escopeta de manera permanente.

9. NO SUBA A LOS ÁRBOLES NI SALTE CERCA O ZANJAS CON UNA ESCOPETA DE AIRE COMPRIMIDO CARGADA.

Antes de subir o bajar de un árbol, saltar una cerca o una zanja o cualquier otro obstáculo, abra el cañón. Nunca tire o empuje una escopeta de aire comprimido cargada hacia usted mismo o hacia otra persona.



11. NO TRANSPORTE NUNCA UNA ESCOPETA DE AIRE COMPRIMIDO CARGADA.

Descargue la escopeta antes de meterla en el vehículo. Los cazadores y tiradores deben cargar la escopeta de aire comprimido una vez hayan llegado a destino.



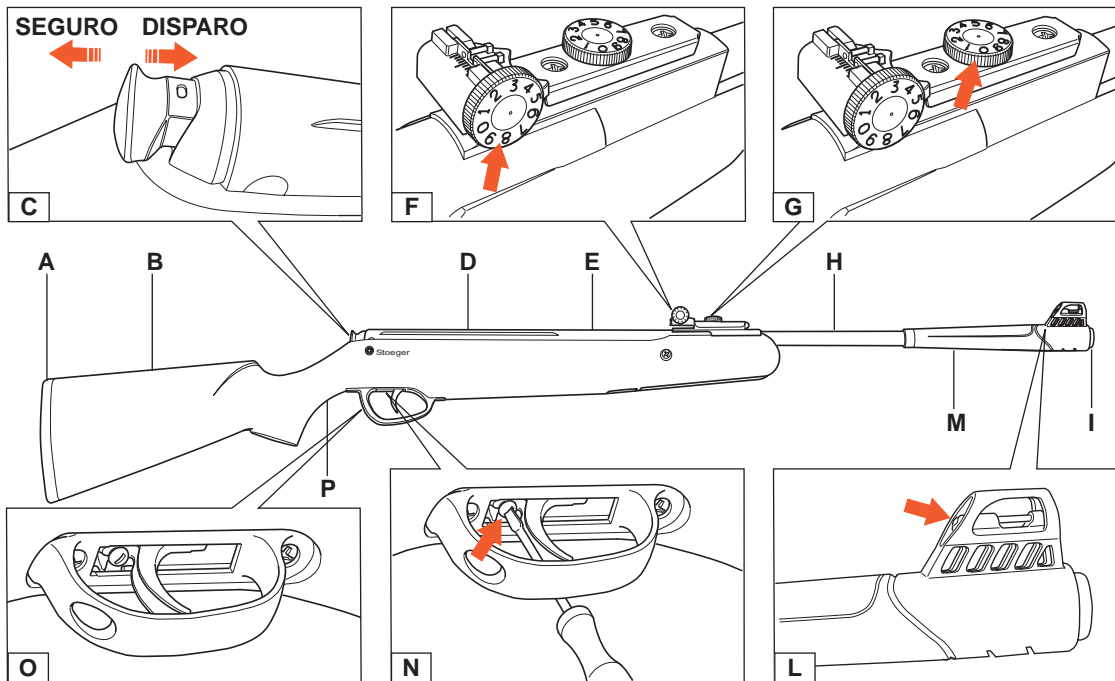

1 PARTES DE LA ESCOPETA

- A Cantenera
- B Culata
- C Seguro
- D Rail para montar la óptica

- E Cilindro de compresión
- F Guía de regulación
- G Guía de regulación elevación
- H Cañón
- I Boca del cañón

- L Mira delantera con fibra óptica
- M Empuñadura
- N Tornillo de regulación del gatillo
- O Guardamonte
- P Empuñadura tipo pistola

E

2 MANEJO SEGURO

Su escopeta de aire comprimido posee un seguro de bloqueo automático, que se activa automáticamente cuando se arma la escopeta. La corredera del seguro está situada al final del tubo de compresión (**fig. C**):

- Hacia atrás = bloqueo disparo (Safe)
Botón del seguro completamente hacia atrás - se ve un punto blanco - seguro activado o en posición de "seguridad"
- Hacia delante = disparo (Fire)
Empujar el botón de seguridad completamente hacia adelante - el punto blanco no está visible - el seguro está desactivado o en posición de "fuego"

3 AJUSTE DEL GATILLO

El gatillo viene ajustado de fábrica y la mayoría de los tiradores no necesitan ajustarlo. Este gatillo de doble fase está equipado con un tornillo de ajuste para el ajuste de la longitud de la segunda fase (**fig. N**).

Esta característica está reservada sólo para tiradores con experiencia, para los modelos X10, X20, X20 Suppressor, Atac, Atac Suppressor y X50.

- Para reducir la longitud de la segunda fase, gire el tornillo en el sentido de las agujas del reloj.
- Para aumentar la longitud de la segunda fase, gire el tornillo en sentido opuesto al de las agujas del reloj.

4 MONTAJE

Apunte la escopeta de aire comprimido hacia una dirección segura teniendo el dedo alejado del gatillo (**fig. Q**).

Con una mano agarre la culata por la empuñadura. Sujetando firmemente la escopeta, **presione sobre la parte final del cañón hacia abajo** para desbloquearlo (**fig. R**).

Agarre el cañón más allá de la mira delantera y tire hacia abajo hasta el stop. Escuchará el clic de bloqueo del mecanismo del gatillo cuando lo suelta. Tiene que agarrar fuerte, y no soltar, el cañón hasta escuchar el clic. Tenga cuidado de no pillarse la mano o los dedos en la zona de la articulación (**fig. S**).

5 CARGA

Compruebe el balín para asegurarse de que se ajuste con el calibre de la escopeta de aire comprimido. Inserte el balín en el cañón hasta que esté a nivel de la superficie de la recámara (**fig. T**). Mueva el cañón de nuevo en su posición de bloqueo original.

Otra vez, tenga cuidado de no pillarse la mano o los dedos en la zona de la articulación (**fig. U**).

6 DISPARO: APUNTAR Y DISPARAR

Mantenga el dedo lejos del mecanismo del gatillo hasta estar delante del blanco, empuje el botón del seguro completamente hacia adelante, apriete el gatillo. El seguro se puede volver a poner en la posición de "On" o de "Seguridad" en cualquier momento tirándolo completamente hacia atrás (punto blanco no visible).

A) No correcto (**fig. V**)

B) Correcto (**fig. Z**)

Su escopeta de aire comprimido está equipada con una mira trasera ajustable sea para la elevación (1) (arriba-abajo) sea para el rozamiento con el aire (derecha-izquierda) (2).

El ajuste de la elevación está marcado en el tornillo de elevación y se controla girando el tornillo de elevación 1.

- Gire en el sentido de las agujas del reloj para disparar los balines más hacia abajo
- Gire en sentido opuesto al de las agujas del reloj para disparar los balines más hacia arriba

El ajuste del rozamiento con el aire, derecha o izquierda, está marcado en la escala móvil y se controla girando el tornillo de pérdida por rozamiento 2.

- Gire en el sentido de las agujas del reloj para disparar los balines más hacia la derecha
- Gire en sentido opuesto al de las agujas del reloj para disparar los balines más hacia la izquierda.

La escala y los números no tienen que aplicarse para las distancias, sino que sirven solo como referencia.

7 MANTENIMIENTO DE LA ESCOPETA DE AIRE COMPRIMIDO

El cuidado de la escopeta de aire comprimido necesita muy poca limpieza y mantenimiento.

Piezas mecánicas:

Hay que limpiar el cañón periódicamente, antes de guardar la escopeta o por lo menos después de 500 disparos, con una varilla limpiadora (evite utilizar cepillos de metal para la preservación de las estrías), o con una bala limpiadora que hay que disparar como si se tratara de una bala real. Puede aplicar unas gotas de aceite en el cañón.

Cada 1000 disparos, aplique una gota de lubricante para escopetas en la cámara de compresión (fig. W).

Las partes de color azul, como el cañón y el cilindro de compresión, deberían estar protegidas por medio de un tratamiento contra la oxidación. Mantenga la protección limpiando estas partes con un tampón mojado en aceite.

Todas las piezas mecánicas visibles, la recámara, el gatillo y el seguro, tienen que engrasarse periódicamente para mantener un funcionamiento correcto.

Cuidado de la culata:

Las culatas sintéticas no necesitan mantenimiento excepto limpiarlas del barro, de la sangre, etc., y luego secarlas con un paño suave o una toallita. Las culatas de madera tienen que guardarse exclusivamente en locales a temperatura ambiente, porque el calor excesivo puede hacer que agrieten. Una vez secas, se puede pulir delicadamente el esmalte.

Conservación:

- No deje la escopeta en posición de amartillado, esto debilitaría el muelle real.
- Descargue su escopeta disparando hacia una dirección segura y respete siempre todas las normas de seguridad.
- No deje la escopeta en un ambiente húmedo.

ATENCIÓN

- **No intente desmontar su escopeta de aire comprimido. Llévela a un centro de asistencia autorizado.**
- **No modifique su escopeta de aire comprimido, una alteración que varíe la configuración del arma descrita en este manual puede volver su escopeta poco segura y esto invalidaría la garantía.**
- **Toda modificación no autorizada puede volver la escopeta poco segura de usar, causando lesiones graves o la muerte.**
- **No dispare la escopeta sin el perdigón en el cañón (fuego seco), esto podría dañar su escopeta de manera permanente.**

8 ASISTENCIA Y REPARACIONES

Contacte la tienda en donde ha comprado su escopeta para conseguir asistencia o saber quién es el distribuidor oficial en su país.

El listado de los Distribuidores Oficiales de los productos Stoeger está disponible en: "stoegeairguns.com".

E

GARANTÍA

Todas las Carabinas Stoeger tienen una garantía de 2 años a contar desde la fecha de compra del arma.

Los daños accidentales, los daños debidos al incumplimiento de los consejos descritos en este manual y al desmontaje no autorizado excluyen la escopeta de la garantía.

La garantía no cubre:

- Uso incorrecto y accidentes
- Falta de cuidado y mantenimiento
- Incumplimiento de las instrucciones contenidas en el manual del fabricante
- Desgaste y rotura normales
- Oxidación o corrosión
- Obstrucción del cañón

Las piezas de madera están excluidas de las reparaciones cubiertas por la garantía. Esta garantía no cubre la quejas hechas por los segundos propietarios de cualquier producto Stoeger.

LEGGERE ATTENTAMENTE LE ISTRUZIONI E LE PRECAUZIONI D'USO CONTENUTI IN QUESTO MANUALE PRIMA DI UTILIZZARE LA CARABINA AD ARIA COMPRESSA.

Ci congratuliamo con Voi e Vi ringraziamo per aver acquistato la nuova carabina ad aria compressa a pallini STOEGER.

ATTENZIONE

QUESTA CARABINA AD ARIA COMPRESSA NON È UN GIOCATTOLO E DEVE ESSERE UTILIZZATA ESCLUSIVAMENTE DA PERSONE MAGGIORENNI.

SI PREGA DI LEGGERE ATTENTAMENTE L'INTERO MANUALE DELL'UTENTE. TRATTARE SEMPRE LA CARABINA AD ARIA COMPRESSA COME SE FOSSE UN'ARMA VERA E PROPRIA.

ATTENZIONE

SEGUIRE ATTENTAMENTE LE ISTRUZIONI RELATIVE ALLA SICUREZZA CONTENUTE IN QUESTO MANUALE E CONSERVARE CON CURA IL MANUALE PER L'UTILIZZO FUTURO. NON VENDERE LA CARABINA AD ARIA COMPRESSA SENZA IL RELATIVO MANUALE DELL'UTENTE.

IL PROPRIETARIO E L'UTENTE SONO TENUTI ALL'INTEGRALE RISPETTO DELLE LEGGI LOCALI RIGUARDANTI LA DETENZIONE E L'UTILIZZO DELLE CARABINE AD ARIA COMPRESSA.

SOMMARIO

1	Particolari carabina ad aria compressa	37
2	Maneggio in sicurezza.....	38
3	Regolazione del grilletto	38
4	Armamento	38
5	Caricamento	38
6	Tirare: mirare e sparare	38
7	Manutenzione.....	39
8	Assistenza e riparazioni.....	39

***Il presente manuale può essere soggetto a modifiche senza
notifica preventiva.***

NORME RELATIVE ALLA SICUREZZA DELLA CARABINA AD ARIA COMPRESSA

1. NON PUNTARE MAI LA CARABINA AD ARIA COMPRESSA CONTRO QUALCOSA A CUI PUÒ ESSERE PERICOLOSO SPARARE.

Non puntare mai un'arma contro qualsiasi parte del Vostro corpo o contro un'altra persona. Ciò è particolarmente importante quando si carica o si scarica la carabina ad aria compressa

Quando si spara contro un bersaglio occorre accertarsi di cosa vi sia dietro.

Nel caso in cui il bersaglio venga mancato o trapassato, è Vostra responsabilità accertarVi che il proiettile non possa causare lesioni o danni involontari a persone o cose.



2. UNA CARABINA AD ARIA COMPRESSA PUÒ CAUSARE DANNI PERMANENTI O MORTE. TRATTARE SEMPRE UNA CARABINA COME UN'ARMA VERA E PROPRIA E COME SE FOSSE CARICA.

Non presupporre mai che una carabina ad aria compressa sia scarica.

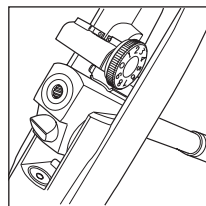

L'unico modo per assicurarsi che in una carabina non vi siano dei pallini in canna, è quello di esaminare visivamente l'interno della canna per vedere

che non sia presente un pallino.

3. CUSTODIRE LA CARABINA AD ARIA COMPRESSA AL DI FUORI DELLA PORTATA DEI BAMBINI.

È responsabilità del proprietario della carabina fare in modo che bambini e giovani al disotto della maggiore età, od altre persone non autorizzate, non abbiano accesso ad essa se non supervisionate.

Per ridurre il rischio di incidenti che possono coinvolgere bambini, mettere la carabina sotto chiave e riporre i pallini in un luogo separato, anch'esso chiuso a chiave.

Occorre tener presente che, i sistemi impiegati per prevenire gli incidenti quali ad esempio i lucchetti con filo metallico, il blocco grilletto ecc., non possono da soli impedire l'uso o l'abuso della carabina ad aria compressa da parte di una persona intenzionata a farlo. Gli armadietti d'acciaio sono la soluzione più indicata per ridurre la possibilità di abuso intenzionale della carabina da parte di bambini o di persone non autorizzate.

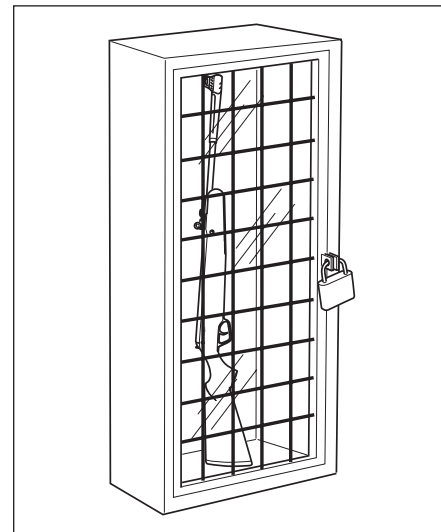

4. NON SPARARE MAI CONTRO SPECCHI D'ACQUA O CONTRO SUPERFICI DURE.

Sparare contro uno specchio d'acqua, contro una roccia o altra superficie dura, aumenta la possibilità di rimbalzi o frammentazione dei pallini, che potrebbero involontariamente colpire un bersaglio secondario.



5. ACCERTARSI DI CONOSCERE I DISPOSITIVI DI SICUREZZA DELLA CARABINA AD ARIA COMPRESSA CHE SI STA USANDO, MA RICORDATE: TALI DISPOSITIVI NON SOSTITUISCONO LE NORME DI SICUREZZA E DI MANEGGIO.

Mantenere la carabina "in sicura" fino al momento in cui si è pronti a sparare, tuttavia per prevenire gli incidenti non fare mai affidamento solo sui dispositivi di sicurezza. È indispensabile conoscere ed utilizzare i dispositivi di sicurezza specifici della carabina ad aria compressa che si sta maneggiando, ma gli incidenti possono essere prevenuti nel modo migliore, seguendo le procedure di maneggio in sicurezza, descritte in queste norme ed all'interno del libretto di istruzioni.

Per prendere maggiore confidenza con le regole per l'uso appropriato delle carabine ad aria compressa, è consigliabile seguire un Corso di Sicurezza sulle carabine, tenuto da esperti nell'utilizzo e nelle procedure di sicurezza.

6. EFFETTUARE UNA MANUTENZIONE APPROPRIATA DELLA CARABINA AD ARIA COMPRESSA.

Custodire e trasportare la carabina ad aria compressa in modo tale che lo sporco o la polvere non si accumulino nei meccanismi di funzionamento. Pulire ed oliare la carabina ad aria compressa, seguendo le indicazioni fornite in questo manuale, dopo ogni utilizzo, per prevenire la corrosione, danni alle canne o accumulo di sporco.

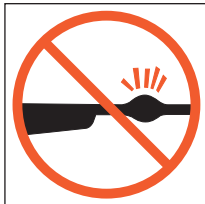

Controllare sempre la canna prima di caricare l'arma, per accertarsi che sia pulita e libera da eventuali ostruzioni. **Sparare con un'ostruzione nella canna può determinare un aumento di pressione e causare lesioni a Voi stessi ed alle persone a Voi vicine.** Qualora lo sparo produca un rumore anomalo, interrompere immediatamente il tiro, mettere la carabina ad aria compressa in sicura e scaricarla. Verificare quindi che la canna sia libera da ostruzioni.

7. USARE PALLINI APPROPRIATI.

Assicurarsi che ogni pallino utilizzato sia del calibro adeguato alla carabina ad aria compressa che si sta utilizzando. Il calibro della carabina ad aria compressa è chiaramente impresso sulle canne. L'uso di pallini di scarsa qualità può influire sulla precisione del tiro o ostruire la canna, a causa di un accumulo di pallini all'interno di quest'ultima.

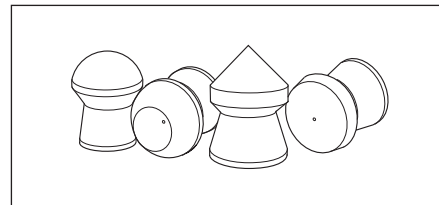

8. PORTARE SEMPRE OCCHIALI PROTETTIVI DURANTE IL TIRO.

I pallini o frammenti di metallo possono essere proiettati all'indietro o rimbalzare, causando gravi lesioni, compresa la perdita della vista. Sparando, il tiratore e le persone presenti devono sempre indossare occhiali protettivi, adeguatamente resistenti.



9. NON ARRAMPICARSI MAI SU ALBERI, NON SCAVALCARE SIEPI E NON SALTARE FOSSI CON UNA CARABINA AD ARIA COMPRESSA CARICA.

Scaricare sempre l'arma prima di arrampicarsi su alberi o scendere da essi, prima di scavalcare una siepe o saltare un fosso o qualsiasi altro ostacolo. Non tirare né spingere mai una carabina ad aria compressa verso Voi stessi od altra persona.



10. EVITARE DI ASSUMERE BEVANDE ALCOOLICHE O MEDICINALI CHE POSSANO RIDURRE LA CAPACITA' DI GIUDIZIO ED I RIFLESSI DURANTE IL TIRO.

Evitare di bere alcolici prima di sparare. Se si assumono medicinali che possono determinare una riduzione delle capacità motorie o di giudizio, non maneggiare l'arma mentre si è sotto l'effetto di tali sostanze.



11. NON TRASPORTARE MAI UNA CARABINA AD ARIA COMPRESSA CARICA.

Scaricare sempre la carabina ad aria compressa prima di caricarla a bordo di un veicolo. Cacciatori e tiratori devono caricare la carabina solo quando sono giunti a destinazione.



12. NON SPARARE MAI CON LA CARABINA AD ARIA COMPRESSA SENZA PALLINI IN CANNA.

Potrebbe provocare danni irreparabili alla carabina.

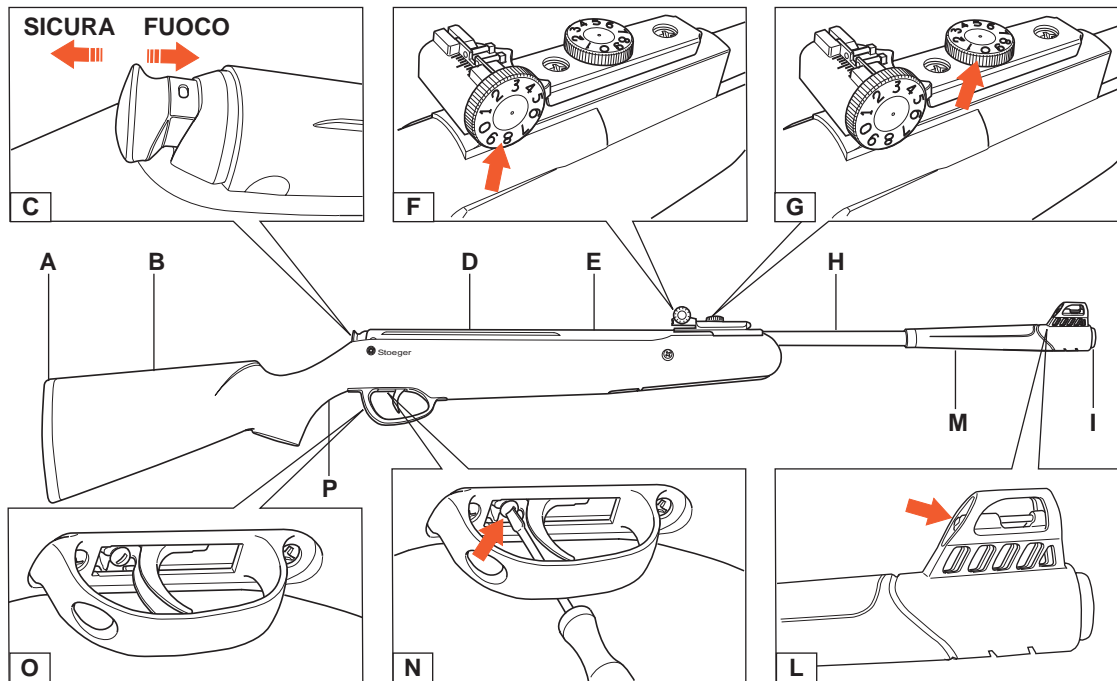

1 PARTICOLARI DELLA CARABINA

- A Calciolo
- B Calcio
- C Sicura
- D Guida per il montaggio di ottica

- E Pistone
- F Ghiera per regolazione derivazione
- G Ghiera per regolazione elevazione
- H Canna
- I Bocca del fucile

- L Mirino anteriore con fibra ottica
- M Impugnatura
- N Vite di regolazione gioco grilletto
- O Sottoguardia
- P Impugnatura a pistola

2 MANEGGIO IN SICUREZZA

La Vostra carabina ad aria compressa ha un sistema di messa in sicura automatico, che si attiva automaticamente quando armate la carabina. L'astina di sicurezza è situata alla fine del tubo di compressione (**fig. C**):

- Indietro = in sicurezza (Safe)
Il pulsante della sicura fuoriesce all'indietro completamente - il puntino bianco è visibile - la sicura è quindi INSERITA o in posizione di "sicurezza"
- Avanti = fuoco (Fire)
Spingere completamente in avanti il pulsante della sicura - il puntino bianco non è visibile - la sicura è quindi DISINSERITA e nella posizione "fuoco."

3 REGOLAZIONE DEL GRILLETTO

Il grilletto è regolato in fabbrica e la maggior parte degli utilizzatori non avrà bisogno di alcuna regolazione personalizzata.

Questo grilletto è dotato di una vite di regolazione, per la calibrazione della lunghezza gioco pre-scatto (**fig. N**).

Questa caratteristica è riservata ai tiratori più esperti per i modelli X10, X20, X20 Suppressor, Atac, Atac Suppressor e X50.

- Per ridurre la lunghezza del gioco, girare la vite in senso orario.
- Per aumentare la lunghezza del gioco, girare la vite in senso antiorario.

4 ARMAMENTO

Puntare la carabina ad aria compressa in direzione di sicurezza mantenendo sempre il dito lontano dal grilletto (**fig. Q**).

Con una mano afferrare il calcio nell'impugnatura a pistola. Mantenendo la carabina ben salda, **colpire con la mano la parte della canna dietro al mirino anteriore**, per liberarla dalla posizione di blocco (**fig. R**).

Afferrare la canna nella parte dietro al mirino anteriore e tirarla verso il basso fino allo stop. Si deve avvertire il click della messa in sicurezza del grilletto quando rilasciate. Finché non si avverte il click, è necessario controllare saldamente la canna e non rilasciarla. Fare attenzione a non inserire le mani o le dita nella zona basculante (**fig. S**).

5 CARICAMENTO

Verificare che i pallini siano adeguati al calibro della carabina ad aria compressa. Introdurre i pallini nella canna fin tanto che essi non risultano a livello della superficie della culatta (**fig. T**).

Riportare la canna alla sua posizione di blocco originaria.

Fare nuovamente attenzione a non inserire le mani o le dita nella zona basculante (**fig. U**).

6 TIRARE: MIRARE E SPARARE IL COLPO

Mantenere le dita lontane dal sottoguardia durante la mira, spingere completamente in avanti il pulsante della sicura, premere il grilletto. La sicura può essere "inserita" o in posizione di "sicurezza" ogni qualvolta si tiri indietro completamente (il puntino bianco è visibile).

A) Errato (**fig. V**)

B) Corretto (**fig. Z**)

La carabina ad aria compressa è dotata di un mirino posteriore regolabile sia per l'elevazione (alto-basso) (1) che per la derivazione (destra-sinistra) (2).

Le possibili regolazioni di elevazione sono marcate nella vite di elevazione e si effettuano ruotando la ghiera 1 di elevazione.

- Ruotare in senso orario per sparare più in basso
- Ruotare in senso antiorario per sparare più in alto

Le possibili regolazioni di derivazione, destra o sinistra, sono marcate nell'indicatore scorrevole e si effettuano ruotando la ghiera 2 per la regolazione della derivazione.

- Ruotare in senso orario per sparare più a destra
- Ruotare in senso antiorario per sparare più a sinistra.

Le scale di misurazione ed i numeri non indicano le distanze, ma hanno soltanto una funzione di riferimento.

7 MANUTENZIONE CARABINA

La cura della carabina ad aria compressa richiede una pulizia ed una manutenzione minime.

Parti meccaniche:

La canna deve essere pulita prima di essere riposta o comunque dopo 500 spari con un'apposita asta per la pulizia (evitare le spazzole in ottone per mantenere al meglio la rigatura) o utilizzando dei pallini pulenti, che vanno sparati come normali pallini. Applicare una goccia di olio all'interno della canna.

Ogni 1000 spari, applicare una goccia di olio per fucili nella camera di compressione (fig. W).

Le parti colorate in blu, come la canna o il cilindro di compressione dovrebbero avere un trattamento antiruggine. Mantenere questa protezione, pulendo tali parti con tamponi oliati.

Tutte le parti meccaniche visibili, culatta, grilletto e sicura, possono essere sottoposte a lubrificazione per mantenere una corretta funzionalità.

Manutenzione del calcio:

I calci in materiale sintetico non richiedono alcuna manutenzione; pulire con un panno morbido. I calci in legno debbono essere esclusivamente custoditi in locali a temperatura ambiente poiché il calore eccessivo potrebbe provocarne l'incrinatura. I calci in legno debbono essere puliti con olio e un panno morbido.

Custodia:

- Non riporre la carabina in posizione armata, per evitare di indebolire la molla principale.
- Scaricare la carabina ad aria compressa sempre in direzione di sicurezza e rispettare sempre le norme di sicurezza.
- Non riporre la carabina in ambienti umidi.

- ATTENZIONE**
- **Non cercare di smontare la carabina ad aria compressa. Recarsi presso un punto di assistenza autorizzato.**
 - **Non modificare la carabina ad aria compressa; l'utilizzo in modi differenti da quelli indicati in questo manuale, può rendere la carabina pericolosa e determinerà l'annullamento della garanzia.**
 - **Qualsiasi modifica può rendere l'utilizzo della carabina pericoloso e provocare lesioni gravi o decessi.**
 - **Sparare con la carabina senza pallini in canna può provocare danni irreparabili alla carabina.**

8 ASSISTENZA E RIPARAZIONI

Contattate il vostro negoziante per una prima assistenza o il distributore ufficiale della vostra zona.

L'elenco dei Distributori Ufficiali Stoeger Airguns è disponibile sul sito: "stoegerairguns.com".

GARANZIA

Tutte le carabine Stoeger Airguns sono coperte da garanzia per un periodo di 2 (due) anni a partire dalla data d'acquisto.

Danni accidentali o indiretti causati dall'inosservanza delle avvertenze descritte nel presente manuale e smontaggio non autorizzato non sono coperti da garanzia.

Non sono coperti da garanzia:

- Utilizzo improprio che provochi danni accidentali/incidenti
- Mancata cura e manutenzione
- Inosservanza delle istruzioni descritte nel manuale
- Logorio e usura
- Ruggine e corrosione
- Ostruzioni nella canna

Le parti in legno non sono coperte da garanzia. La presente garanzia non copre i reclami su prodotti Stoeger presentati da proprietari successivi.

