



# JTS<sup>®</sup>

## AIRGUNS

### OWNER'S INSTRUCTION MANUAL

PCP Pellet Rifle: Cal. .22 (5.5 mm) OR .25 (6.35 mm) 

**920**   
.22 caliber

**900**   
.25 caliber

**10x**  
Rotary Mag

**3000**  
PSI TANK



# Airacuda

MODEL	CALIBER	VELOCITY	DANGER DISTANCE
JTS <sup>®</sup> Airacuda	.22	920 fps (280 m/s)	550 yds (503 m)
JTS <sup>®</sup> Airacuda	.25	900 fps (274 m/s)	550 yds (503 m)

**⚠ WARNING** NOT A TOY. THIS AIRGUN IS RECOMMENDED FOR ADULT USE ONLY. USE MAY CAUSE SERIOUS INJURY OR DEATH. MAY BE DANGEROUS UP TO 550 YARDS (503 METERS). This is a high powered airgun for use by those 18 years of age or older. Read this owner's manual before using. The purchaser and user should conform to all laws governing the purchase, use and ownership of airguns.

## CONTENTS



1 |  SAFETY INSTRUCTIONS

2 |  CARE

3 |  DESCRIPTION

4 |  OPERATION

Airguns differ in their operation and you are never ready to fire any gun until you are thoroughly familiar with it. Read the following operating instructions thoroughly prior to operating.

These symbols and safety signal words,   **NOTICE**, mark warnings, cautions, and notices in this owner's manual. Carefully follow them for your own safety and the safety of others.

READ THIS OWNER'S MANUAL COMPLETELY. This airgun is not a toy. Treat it with the same respect you would a firearm. Always carefully follow the safety instructions found in this owner's manual and keep this manual in a safe place for future use.



**Eye protection required. Wear your shooting glasses.**

**⚠ WARNING** Do not brandish or display this airgun in public – it may confuse people and may be a crime. Police and others may think it is a firearm. Do not change the coloration and markings to make it look more like a firearm. That is dangerous and may be a crime.

### **⚠ CAUTION**

Failure to follow the instructions and recommendations in this owner's manual may result in bodily injury including face, eye, and ear injury, blindness, or deafness.

## SAFE HANDLING OF AIRGUNS

Learn how to handle your gun in a safe and proper manner. Remember that according to the basic rules of safety, touching a gun is the same as handling it.

- You and others with you **MUST** always wear shooting glasses to protect your eyes. If you wear reading glasses the lenses must be certified for impact resistance or you should wear safety glasses intended for use over normal optical reading glasses.
- Always aim in a **SAFE DIRECTION**. Always keep the muzzle of the airgun pointed in a **SAFE DIRECTION**.
- Always keep your finger off the trigger and out of the trigger guard until ready to shoot.
- Never point the airgun at anything you do not intend to shoot.
- Always treat the airgun as though it is loaded and with the same respect you would a firearm.
- Never look down the barrel of an airgun.
- Always keep the airgun "ON SAFE" until you are ready to shoot.
- Always check to see if the airgun is "ON SAFE" and unloaded when getting it from another person or from storage.
- Use only the proper size and type of projectile as it is marked on the airgun.
- Never reuse ammunition.
- Do not shoot at hard surfaces or at the surface of water. The pellet may bounce off or ricochet and hit someone or something you had not intended to hit.
- Do not shoot at fragile objects such as windows.
- Place the backstop in a location that will be safe should the backstop fail.
- Your backstop should be checked for wear before and after each use. All backstops are subject to wear and will eventually fail. Replace your backstop if the surface is worn or damaged or if a ricochet occurs.
- Do not attempt to disassemble or tamper with your airgun. Unauthorized repairs or modifying the function of your airgun in any way may be unsafe and will void your warranty.
- Before you store your airgun, make sure it is unloaded, the air is released from the compressed air chamber, and the airgun is "ON SAFE."
- Always store your airgun in a secure location away from unauthorized users and separate from ammunition.

## I. LEARNING THE PARTS OF YOUR AIRGUN

Illustration 1

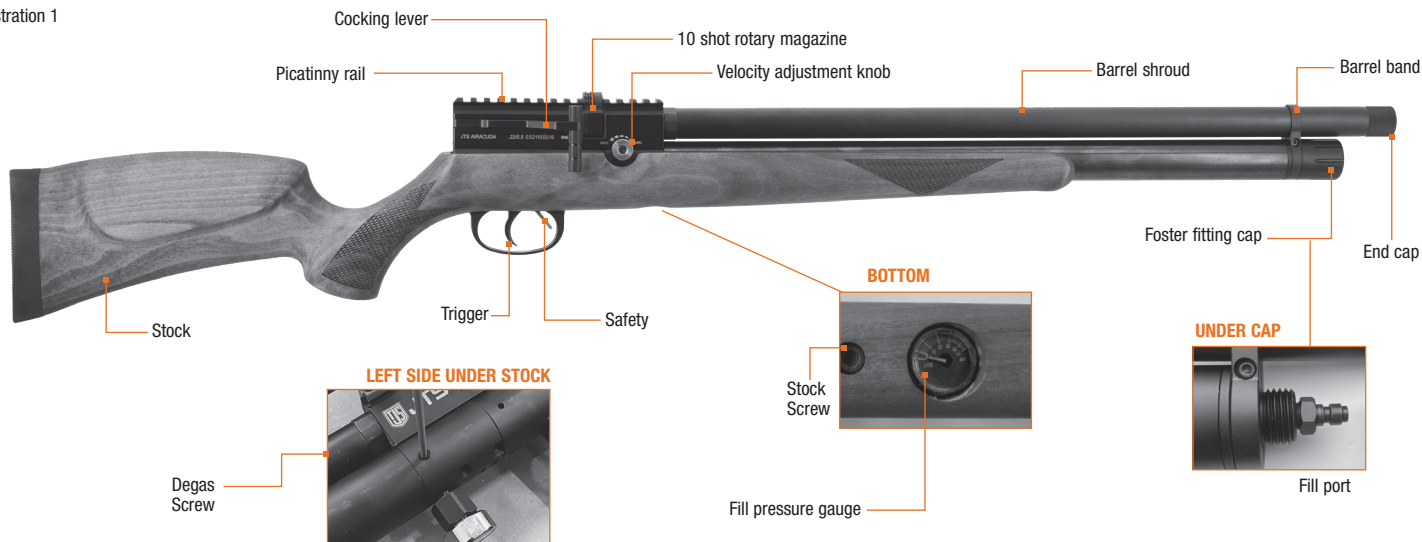

### TECHNICAL DATA

MODEL	.22 cal.	.25 cal.
Velocity	920 FPS	900 FPS
Caliber	.22 (5.5 mm)	.25 (6.35 mm)
Magazine capacity	10 rounds	
Length	41 inch (104 cm)	
Barrel length	18 inch (45.7 cm)	
Weight	7 lb (3.18 kg)	
Tank pressure	3000 psi	
Safety	Manual	
System	PCP	

**⚠ WARNING** This airgun can cause serious injury or death. Read and follow the instructions carefully. Do not load a projectile into the airgun until you are ready to shoot. If you do load a projectile and then decide not to shoot, remove it either manually or by shooting the airgun at a safe target. An unloaded, uncocked airgun which is "ON SAFE" is safest. Accidents happen fast, please handle the airgun safely.

### ⚠ CAUTION

The components of this airgun were engineered and manufactured to deliver optimum performance. Any modification or tampering with an airgun may cause a malfunction, void your warranty and may make it unsafe to use. Any change in performance (such as a lowered trigger pull force and shortened trigger travel) indicates possible modification, tampering and/or wear. Such air rifle should be inspected, replaced, or properly repaired by only qualified JTS® Group personnel. Any airgun that has been dropped should be checked by qualified personnel to ensure that its function has not been affected.

## 2. OPERATING THE SAFETY

**⚠ WARNING** Be sure the airgun is always pointed in a safe direction. Never point the airgun at any pet or person even if it is uncocked and unloaded. Always assume and handle the airgun as if it were loaded and ready to fire.

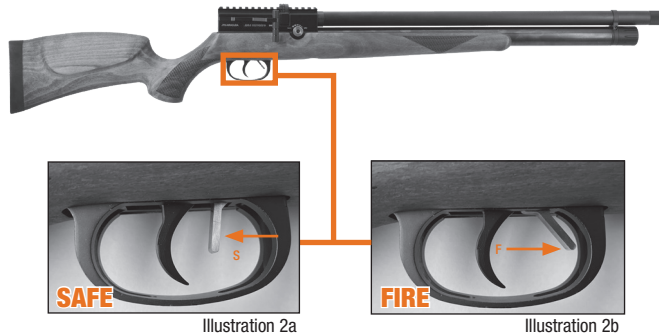

Illustration 2a

Illustration 2b

The JTS® Airacuda has the safety as shown in **illustration 2**.

- To put "ON SAFE", pull the safety lever rearward towards the trigger (**illustration 2a**).
- To put "OFF SAFE" (on fire), flip the safety lever forward towards the muzzle (**illustration 2b**).

### ⚠ CAUTION

Before you put your air rifle "OFF SAFE," be absolutely certain that your air rifle is pointed in a safe direction and that you are ready to fire. Once your air rifle is cocked and manually placed "ON SAFE," see **Section 2: Operating the Safety** for instruction on how to put the Airacuda "ON SAFE".

### ⚠ CAUTION

Like all mechanical devices, an airgun safety can fail. Even when the safety is "ON SAFE," you should continue to handle the airgun safely. Never point the airgun at anything you do not intend to shoot.

## 3. CHARGING YOUR AIR RIFLE

The JTS® Airacuda airgun is equipped with an air reservoir which is approved for compressed air up to 3000 psi. This reservoir can be filled at any time using the integrated foster fitting. **DO NOT ATTEMPT TO REMOVE THE AIR RESERVOIR.**

**⚠ WARNING** Do not overfill airgun tank. Excessive pressure can damage airgun and may lead to an explosive tank rupture which can cause injury or death.

**⚠ WARNING** Only use compressed air in this airgun. Using other gases, including pure oxygen, may result in damage to the airgun and can cause an explosion that may cause injury or death.

**⚠ WARNING** Before removing filling hose, always bleed the air from the hose using the valve on the pump. Not doing so can result in the hose whipping around, which can cause injury or property damage.

**⚠ WARNING** Petroleum based lubricant must not be used in or with the compressed gas reservoir. Oxygen under pressure can react violently with petroleum based products, resulting in explosions, fire, damage to property, severe injury, and death.

**⚠ WARNING** The compressed air reservoir is not removable. It is a fixed, integral part of the airgun. **DO NOT** attempt to remove it. Removing the reservoir voids the warranty and may lead to serious injury or death.

**NOTICE** Firing the airgun without sufficient tank pressure can result in a pellet jammed in the barrel.

### 3A. READING YOUR AIR RIFLE'S AIR RESERVOIR PRESSURE GAUGE

The pressure in the reservoir can be read on the built-in pressure gauge. The gauge has an accuracy of  $\pm 10\%$ . Temperature variations can also affect the level shown.

For most accurate readings during filling, consult the built-in gauge of the tank, compressor, or hand pump if available.

## CAUTION

Check the pressure level indicator of the compressed air reservoir only when your airgun is unloaded and decocked and when the safety is engaged.

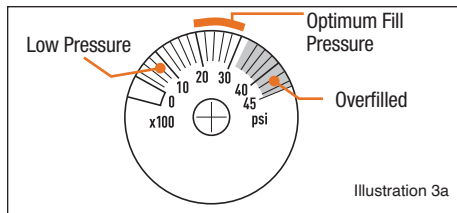

### 3B. FILLING THE AIR RESERVOIR WITH A HAND PUMP

Make sure the air rifle is unloaded, cocked, ON SAFE and pointed in a safe direction. Remove the fill port cover (illustration 3b) and attach the fill port of the Airacuda to the hand pump's foster #12FS quick disconnect socket (illustration 3c). Begin pumping. Continue pumping until the pressure gauge on the air reservoir reads between 1000-3000 psi. DO NOT OVERFILL. Once the desired pressure is reached, bleed the pump hose and disconnect the pump hose from the reservoir. **NOTE:** If pump hose is not bled before disconnecting, the hose may whip when disconnected and could result in injury or property damage.

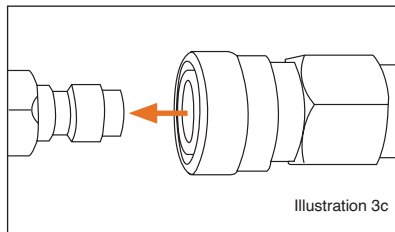
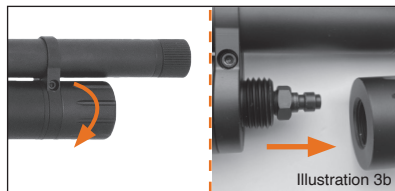

## CAUTION

Use only a hand pump specifically designed for pre-charging high-pressure tanks and that is fitted with a foster #12FS quick disconnect attachment. Do not use a standard air compressor or bicycle pump.

### 3C. FILLING THE AIR RIFLE RESERVOIR WITH A HIGH PRESSURE TANK/BOTTLE

Make sure the air rifle is unloaded, cocked, ON SAFE, and pointed in a safe direction. Attach the fill port of the Airacuda to the high pressure tank or bottle's foster #12FS quick disconnect socket (illustration 3c). Slowly open the valve on the high pressure tank and begin filling the airgun reservoir. **NOTE:** Slowly fill the airgun reservoir. Filling too fast can cause heat to build up, which will result in an inaccurate reading on the reservoir's pressure gauge. Continue filling until the pressure gauge on the airgun reservoir reads between 1000-3000 psi. DO NOT OVERFILL. Once the desired pressure is reached, bleed the high pressure tank/bottle hose and disconnect it from the airgun reservoir. **NOTE:** If pump hose is not bled before disconnecting, the hose may whip when disconnected and could result in injury or property damage.

## CAUTION

When refilling, use only oil-free and water-free compressed air (DIN EN 12021 – breathing air) with a maximum pressure of 3000 PSI (207 bar). Never expose a filled pressure reservoir to a temperature above 122°F (50°C). Do not make alterations to the compressed air reservoir or its valves. Observe applicable national statutory regulations for refilling. Do not refill an air reservoir that leaks or appears unsafe. Empty it in a safe manner.

## CAUTION

Only handle the rifle when it IS unloaded and decocked and when the safety is engaged. Always make sure that the muzzle points in a safe direction.

## 4. DEGASSING YOUR AIR RIFLE

## CAUTION

Do not attempt to disassemble the pre-charged air reservoir. Degassing the air reservoir as described in this manual degasses the air cylinder so that no air can be released from the valve. Please contact JTS® Group for repairs. Do not attempt to disassemble.

**NOTE:** The rifle must be fired or “unsealed” to degas the air tank. The user must be certain there is NOT a pellet in the barrel before degassing the air rifle and the magazine and stock must be removed.

Make sure the airgun is unloaded, uncocked, ON SAFE and pointed in a safe direction. Remove the stock from the receiver by removing the stock screw located on the bottom of the stock (see **illustration 1**). Once the stock is removed, the degassing screw is located on the left side of the rifle's receiver (see **illustration 4**). Slowly turn the degassing screw counter-clockwise to open the degas port and allow the pressurized air to vent. Once you no longer hear gas venting, reattach the stock, double-check to make sure airgun is not loaded, cock the airgun, point in a safe direction, put OFF SAFE and pull the trigger to remove residual gas pressure trapped inside the mechanism. While continuing to point in a safe direction, put ON SAFE and make sure air reservoir gauge shows no pressure in the reservoir.



## **⚠ CAUTION**

Compressed air reservoirs which are leaky, damaged or more than 10 years old should be emptied in a safe manner and not used or filled again. Ten years after the manufacturing date, the compressed air reservoir must be tested at the owner's expense or replaced. The manufacturing date is recorded on the reservoir. JTS® Group does not test compressed air reservoirs.

- If your compressed air reservoir needs repair, call JTS® at 281-647-9130 and ask for the Service Department or contact us at [customerservice@jtsgroup.us](mailto:customerservice@jtsgroup.us). DO NOT ATTEMPT TO DISASSEMBLE IT! Your compressed air reservoir requires special tools and fixtures to repair it. Any disassembly or modification not performed by JTS® Group will void the warranty.
- Do not alter the surface of the compressed air reservoir. In particular, do not engrave it or apply abrasives. This can damage the reservoir and create a safety risk.
- Inspect the compressed air reservoir for cracks and damage before each use.
- Protect the compressed air reservoir against damage of any kind.

The compressed air reservoir has a service life of 10 years. JTS® Group does not test compressed air reservoirs. To find a D.O.T. approved testing facility, do a web search for 'D.O.T. hydrostatic testing' in your area.

Certain conditions may affect the air reservoir, which can impact its proper performance. These conditions include the usage, maintenance and storage at temperatures that are higher or lower than normal outdoors temperatures (normal equals 60°-80° F/16°-27° C) and when rapidly firing the airgun.

1. High temperatures can increase pressure in the air reservoir and also within the airgun, leading to higher than standard operating pressure. This excess pressure could cause the airgun to malfunction or be permanently damaged. Maximum storage or operation temperature should never exceed 122°F (50°C). This temperature can be reached if you leave the airgun under direct sunlight on a bright day. Thus, to ensure proper airgun operation, do not expose it to high temperatures or direct sunlight for long periods of time. Otherwise, the air reservoir could overheat and explode, which could damage the airgun and cause injuries or death to people around it.
2. Care should be exercised to ensure that the airgun is not shot with an air reservoir that is low in pressure. Here are some indicators of insufficient pressure:
  - A) The sound of the shot is not as loud as when the reservoir is full.
  - B) The air hits below the target or at a lower position than it would with a full air reservoir (that is, the velocity has dropped).

## **5. HANDLING & CARE OF AIR RESERVOIRS**

**⚠ WARNING** The air used must comply with din 3188 (breathing air). Do not store the compressed air reservoir at temperatures above 122°F (50°C). Always adhere to the warnings and safety instructions of the manufacturer concerning the handling and storage of the compressed air reservoir.

**⚠ WARNING** Compressed air reservoirs may explode at temperatures above 122°F (50° C). Do not mutilate or incinerate them. Do not expose compressed air reservoirs to temperatures above 50°C (122°F), such as in a vehicle parked in the sun.

**⚠ WARNING** Do not transport the JTS® Airacuda air rifle by airplane. Do not ship it overnight or second day. Only transport the air rifle by ground shipment.

## 6. LOADING YOUR AIR RIFLE

Make sure the airgun is ON SAFE. Block the magazine pellet pass-through with your finger (**illustration 5a**) and insert the first pellet **HEAD FIRST** into the open slot in the front of the magazine (**illustration 5b**), making sure that the pellet head does not stick out the back of the magazine. Once the first pellet is inserted, rotate and hold the magazine wheel counter-clockwise (**illustration 5c**), stopping at each pellet opening to insert a pellet until mag is full (**illustration 5d**). Slowly release the magazine wheel. Pull back bolt to the rear and lock down (**illustration 5e**), insert magazine on the left side of the receiver front facing towards the rear of the airgun (**illustration 5f**), then close bolt (**illustration 5g**).

**NOTE:** Airgun is now cocked and loaded. Keep ON SAFE and make sure the airgun is pointed in a safe direction at all times.



Illustration 5a

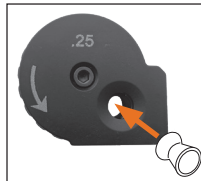

Illustration 5b



Illustration 5c



Illustration 5d



Illustration 5e

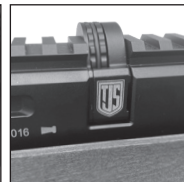

Illustration 5f

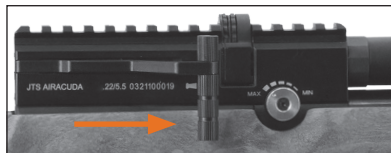

Illustration 5g

### ⚠ CAUTION

Use only .22 (5.5 mm) or .25 (6.35 mm) caliber pellets based on your model. The correct caliber is clearly marked on the receiver of your air rifle. Do not attempt to reuse pellets that have been fired or are deformed. Do not use buck shot, darts, ball bearings, or other foreign objects because they can cause injury to you or someone else or may damage and/or jam the airgun.

**⚠ WARNING** Never carry your air rifle while cocked and/or while loaded. It is best to cock the air rifle only before shooting. Under no circumstances should your air rifle be carried cocked and loaded.

### ⚠ CAUTION

Be careful to keep fingers clear of Bolt and Breech (see "pinch points", **illustration 6**).

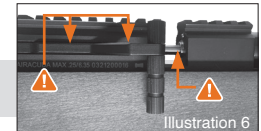

Illustration 6

## 7. AIMING AT A SAFE TARGET

Always aim your air rifle in a SAFE DIRECTION. Always choose your target carefully. It is best to shoot at a paper bullseye target which is attached to a safe backstop. A heavy blanket should be hung behind the target backstop to prevent ricochet should you miss the target. Think about what you will hit if you miss the target.

### ⚠ CAUTION

Your backstop should be inspected for wear before and after each use. Discontinue use if the backstop surface shows signs of failure. Always place the backstop in a location that will be safe should the backstop fail. Discontinue the use of a backstop if the projectile rebounds or ricochets.

## 8. FIRING YOUR AIR RIFLE

When you are absolutely sure your air rifle is aimed at a safe target and you are ready to fire, put your air rifle "OFF SAFE" (see **Section 2**). Squeeze the trigger.

**NOTE:** Many factors affect airgun performance and velocity, including brand of projectile, lubrication, barrel condition, and temperature.

To cycle into the next shot, grasp the cocking lever firmly, avoiding contact with the trigger, pull the cocking lever back (**illustration 7a**), then return it to the front slot (**illustration 7b**).

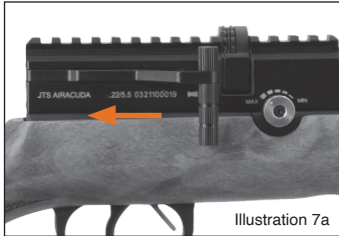

Illustration 7a

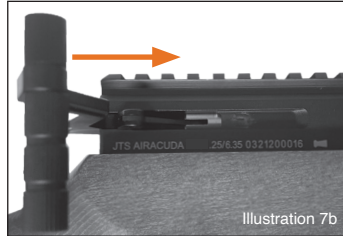

Illustration 7b

## ! CAUTION

Every time the bolt is pulled back and pushed forward a pellet is loaded into the chamber. If done multiple times before pulling the trigger, multiple pellets will be loaded into the barrel and may become lodged inside upon firing.

**! WARNING** If a pellet does not fire after completing the operation steps, the airgun may be jammed. An unfired projectile in the barrel can be a dangerous situation. Keep the airgun pointed in a safe direction and repeat all operation steps except section 3. If a projectile still does not fire, do the following:

1. Put in "ON SAFE" position (see **illustration 2**).
2. Cock the airgun and leave the barrel open with the safety in the "ON SAFE" position.
3. Clear barrel by inserting a cleaning rod through the muzzle end.
4. Repeat operation steps.

**! WARNING** When cocking the air rifle do not place your hand over or in front of the muzzle. Never allow the muzzle to point toward you or anyone else during cocking. Always keep the muzzle pointed in a safe direction.

**! WARNING** Never assume that because the airgun no longer fires a projectile that a projectile is not lodged in the barrel. Always treat the airgun as though it is loaded and with the same respect you would a firearm.

## ! CAUTION

Do not attempt to reuse fired pellets or pellets which are deformed. Projectiles such as steel shot (BBs) and darts may damage your air rifle and cause injury to yourself or bystanders due to ricocheting, and will void the warranty.

## 9. DE-COCKING YOUR AIR RIFLE

To de-cock the Airacuda, point the barrel in a safe direction and remove the magazine. Hold the cocking lever with one hand, then pull the trigger until a clicking noise is heard. Slowly return the cocking lever to the closed position.

## 10. ADJUSTING THE TRIGGER

**NOTE:** Make sure the airgun magazine is removed, barrel is free of any pellets or debris and air chamber is degassed (see **Section 4**) before attempting any adjustments to the trigger mechanism (see **illustration 8**).

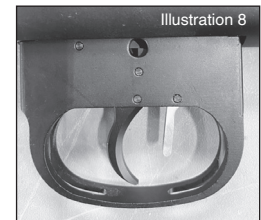

**! WARNING** Adjusting the trigger can prevent proper operation of the safety mechanism and negatively affect sear engagement. If you are not sure that the airgun safety is functioning and/or sear is engaging properly, take your airgun to an experienced gunsmith to be inspected.



**⚠ WARNING** Adjusting the trigger could allow the airgun to fire if dropped, jarred or cocked, with or without the safety engaged.

**⚠ WARNING** This airgun has been classified as an adult air rifle, and is recommended for adult use only. It is considered to be a special-purpose airgun, therefore it is exempt from specific types of trigger pull safety mechanisms and drop tests.

The JTS® Airacuda features a two-stage adjustable trigger: (see **illustration 9**)

- A. First Stage Trigger Take Up Screw (1.5mm Allen wrench required) - Increase the length of trigger movement by turning counterclockwise. Decrease length by turning clockwise
- B. Sear Engagement Screw (1.5mm Allen wrench required) - Increase trigger weight by turning clockwise. Decrease trigger weight by turning counterclockwise.

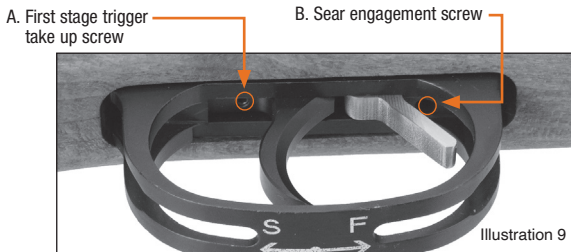

## I I. ADJUSTING THE VELOCITY

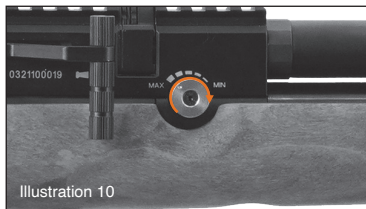

The JTS® Airacuda features an adjustable velocity: (see **illustration 10**)

- Turn the knob clockwise to reduce velocity.
- Turn the knob counter-clockwise to increase the velocity.

## I2. TROUBLE SHOOTING

### I2A. UNLOADING A PELLET

Fire the pellet at a **SAFE TARGET** to unload the airgun. If this is not practical, put the air rifle **ON SAFE**, open the breech, remove the magazine, and push the pellet from the chamber by running a cleaning rod through the muzzle end.

### I2B. REMOVING A JAMMED PELLET

If a pellet is jammed in the barrel, **DO NOT** reload the air rifle.

1. **NEVER LOOK DOWN THE MUZZLE.** Open the breech and remove the magazine, point the air rifle in a **SAFE DIRECTION**, close the breech, put the air rifle in the **OFF SAFE** position and squeeze the trigger to fire.
2. If you believe the air rifle is still jammed, open the breech and insert the correct caliber ramrod (at least 30" in length) into the muzzle and push the jammed pellet out. Do not try to reuse that pellet. If you are not able to unjam your air rifle, contact JTS® Group's Service Department.

### I2C. COMMON PROBLEMS

Problem	Possible cause				
	Safety is engaged	Reservoir is empty	Dirt in barrel	Wrong ammo	Ammo not properly loaded
Poor shooting performance		●	●	●	●
Gun does not shoot	●	●		●	●
Slow projectile		●	●	●	●

## 13. CARE AND MAINTENANCE

### ⚠ CAUTION

Before any care, cleaning or maintenance, always be sure your airgun is unloaded. Keep pointed in a safe direction. It is important to perform routine inspections and maintain your airgun properly.

**NOTICE** Oils that contain acid or resin can damage seals and possibly the finish of the airgun.

**Your JTS® Air Rifle is designed to fire pellets only.** The correct caliber is clearly marked on the air rifle.

**NOTICE** Never use quick cleaning pellets, as they can damage the air rifle.

**NOTICE** Petroleum based lubricant must not be used in the compressed gas reservoir.

**NEVER STORE A LOADED OR COCKED AIRGUN.** Unload pellet from the airgun. Keep air rifle away from children and untrained shooters. Store pellets separately from the air rifle to keep them from untrained shooters. Protect your air rifle from moisture and dirt; clean airgun and wrap it in a smooth, dry cloth. If you are going to store your airgun for an extended length of time be sure the barrel is protected. This can be accomplished by coating the bore with Spring Cylinder Oil. Always use a soft cloth and insert the cleaning rod from the breech end on break barrel rifles. Remove the oil completely before the next use. **REMEMBER:** Always check to see that the airgun is unloaded when getting from storage or from another person.

With care and routine inspections your airgun will provide many sessions of shooting enjoyment. Abuse, neglect and continued exposure to the elements will impair the performance of any airgun.

**WORKING PARTS:** Your air rifle requires very little lubrication. The surfaces around the bolt (see **illustration 11a**), the trigger mechanism and the o-rings on the pellet probe (see **illustration 11b**) should be lubricated with Chamber Oil after every 500 shots. Remember, a little is good—a lot is not better.

**BARREL:** In day to day use, very little dirt or residue will accumulate in the bore. **NOTE:** High quality Lead Pellets not only increase accuracy, they help to reduce lead deposit. During periods of regular use the bore of the barrel should be cleaned periodically by

means of a felt wad or cleaning rod with wool mop that is secured to the cleaning rod. Ensure that the mop is retrieved after cleaning and didn't get lodged in barrel. Insert rod from breech end.

**SURFACE:** The exposed metal parts (receiver, screw heads, trigger, etc.) **MUST** be wiped clean using a slightly oiled cloth after handling to prevent rust. Use light acid free and resin free oil.

**TRIGGER MECHANISM:** Periodically, the screws securing the trigger mechanism to the receiver must be checked for tightness.

### ⚠ CAUTION

Check the tightness of the stock screws between, during, and after screws between, during, and after shooting activity. Loose screws may cause injury or death.

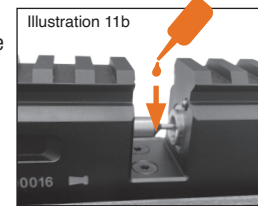
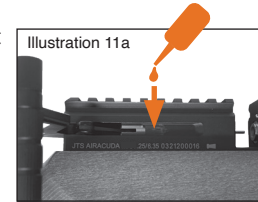

## 14. REPAIR AND SERVICE

**⚠ WARNING** Do not attempt to disassemble the JTS® Airacuda air rifle. It is strictly forbidden for anyone other than JTS® gunsmiths to disassemble the pre-charged air reservoir. Attempted disassembly may cause serious injury or death.

**⚠ WARNING** An airgun that is not operating properly may be dangerous. It should be kept safely from use by anyone until repaired or destroyed. Do not try to take the airgun apart. It is difficult to reassemble and will void the warranty. Improper disassembly or reassembly can cause serious injury or death.

### ⚠ CAUTION

Do not attempt to disassemble the pre-charged air reservoir. Degassing the air reservoir as described in this manual degasses the air cylinder so that no air can be released from the valve. Please contact JTS® for repairs. Do not attempt to disassemble.

Do not return defective or damaged product to the dealer. If your airgun needs repair, call JTS (281) 647-9130 and ask for the Service Department or visit [www.jtsairguns.com](http://www.jtsairguns.com). DO NOT ATTEMPT TO DISASSEMBLE IT! Your airgun requires special tools and fixtures to repair it. Any disassembly or modification not performed by JTS will void the warranty.

**DO NOT RETURN THIS AIRGUN TO THE DEALER:** If you have any questions or concerns about JTS Group products, please contact us at 281-647-9130 or [customerservice@jtsgroup.us](mailto:customerservice@jtsgroup.us) and one of our service techs will be glad to assist you.

**⚠ WARNING** Do not transport the JTS® Airacuda air rifle by airplane. Do not ship it overnight or second day. Only transport the air rifle by ground shipment.

To order replacement parts Online go to [www.jtsairguns.com](http://www.jtsairguns.com).

For service information, contact customer service:  
281-647-9130 • [customerservice@jtsgroup.us](mailto:customerservice@jtsgroup.us)

## 15. JTS® (3) YEARS WARRANTY

The Airacuda airgun is warranted to the retail consumer for three (3) years from date of purchase against defects in material and workmanship and is not transferable.

**WHAT IS COVERED:** Replacement parts and labor.

**WHAT IS NOT COVERED:** Shipping charges to JTS Group for defective product and damages caused by abuse or failure to perform normal maintenance as well as any other expense. Consequential damages, or incidental expenses, including damage to property. Some states do not allow the exclusion or limitation of incidental or consequential damages, so the above limitation or exclusion may not apply to you.

**WARRANTY CLAIMS:** If your JTS airgun is found to have defects in materials or workmanship, we will repair or replace it free of charge for the duration of three (3) years. This warranty does not apply to owner neglect or abuse of the product. Contact JTS for information on how to send your airgun in for repair. DO NOT SHIP YOUR AIRGUN WITHOUT CONTACTING OUR CUSTOMER SERVICE DEPARTMENT FIRST FOR INFORMATION ON HOW TO DO SO.

**JTS Group**  
7724 Cherokee Street  
Katy, TX 77494  
Phone: (281) 647-9130

**IMPLIED WARRANTIES:** Any implied warranties, including the implied warranties of merchantability and fitness for a particular purpose, are limited in duration to three (3) years from date of retail purchase. SOME STATES DO NOT ALLOW LIMITATIONS ON HOW LONG AN IMPLIED WARRANTY LASTS, SO THE ABOVE LIMITATIONS MAY NOT APPLY TO YOU. TO THE EXTENT ANY PROVISION OF THIS WARRANTY IS PROHIBITED BY FEDERAL, STATE, OR MUNICIPAL LAW WHICH CANNOT BE PREEMPTED, IT SHALL NOT BE APPLICABLE. THIS WARRANTY GIVES YOU SPECIFIC LEGAL RIGHTS, AND YOU MAY ALSO HAVE OTHER RIGHTS WHICH VARY FROM STATE TO STATE AND COUNTRY TO COUNTRY.



**Distributed by:**  
**Xisico USA / JTS Airguns**  
**7724 Cherokee Street**  
**Katy, Texas 77494**  
**[www.jtsairguns.com](http://www.jtsairguns.com)**

We reserve the right to make design changes, color changes and technical improvements. No responsibility is accepted for printing errors or incorrect information.



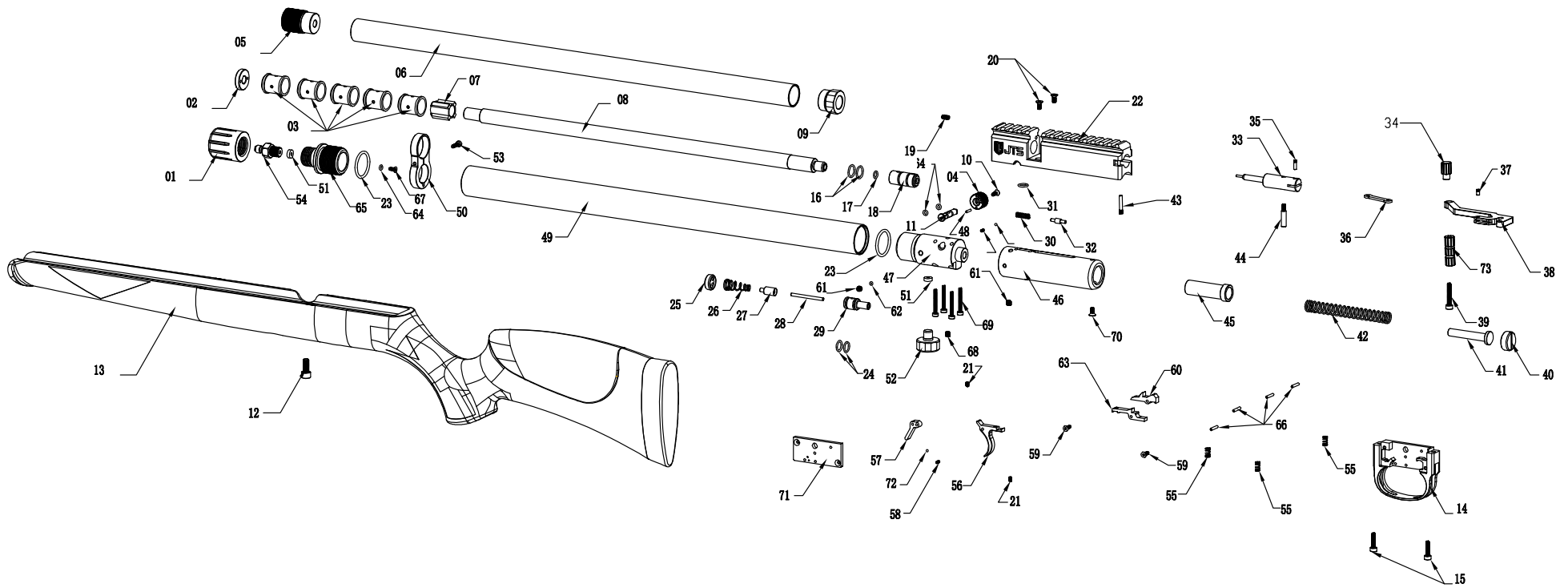

01	Fill probe cover	26	Valve core spring	51	Nylon seal washer
02	Baffle retaining cap	27	Valve core	52	Pressure gauge
03	Suppressor baffles	28	Valve shaft	53	Barrel band screw
04	Velocity adjustment knob	29	Valve seat	54	Foster Fitting
05	Shroud end cap	30	Cocking lever spring	55	Trigger assembly springs
06	Shroud	31	O ring 8x1.5	56	Trigger
07	Barrel centering guide	32	Cocking lever spring guide	57	Safety
08	Barrel	33	Bolt with probe	58	Safety detent spring
09	Shroud rear cap	34	Upper cocking handle	59	Trigger housing cover screws
10	Power adjustment screw	35	Bolt retaining pin	60	Sear
11	Power adjustment valve	36	Cocking lever connector	61	Grub screw
12	Main stock screw	37	Cocking lever connecting pin	62	O ring 1x1.5
13	Stock	38	Cocking lever	63	Connector
14	Trigger housing	39	Lower cocking handle screw	64	O ring 3x1.5
15	Trigger housing screws	40	Hammer spring adjustment cap	65	Air cylinder end cap
16	O ring 11x1.5	41	Hammer spring guide	66	Locating pins
17	O ring *	42	Hammer spring	67	Check valve screw
18	Brass barrel thimble	43	Side lever pivot pin	68	Grub screw
19	Locating pin	44	Hammer cocking screw	69	Valve retaining screws
20	Receiver mounting screws	45	Hammer	70	Rear breech screw
21	Trigger adjusting grub screw	46	Hammer chamber	71	Trigger housing cover
22	Receiver	47	Main valve body	72	Safety detent ball
23	O ring 23x2.5	48	Power adjuster pin	73	Lower cocking handle
24	O ring 11x1.5	49	Pressure tube		
25	Valve spring adjusting cap	50	Barrel band		



## AIRACUDA

\* 6x1.5 -.25 caliber  
5x1.5 -.22 caliber

O ring measurements are inside diameter x cross section in millimeters