

S400 Biathlon



Users Handbook

This handbook refers to S400 Biathlon model.

PLEASE READ THIS MANUAL BEFORE USING YOUR MPR FOR THE FIRST TIME. IT CONTAINS IMPORTANT SAFETY INFORMATION AND INSTRUCTION ON USE, ADJUSTMENT AND MAINTENANCE.



****** SAFETY CODE ******

- 1 *ALWAYS TREAT AN AIR RIFLE AS IF LOADED.*
- 2 *ALWAYS POINT THE RIFLE IN A SAFE DIRECTION, NEVER POINT A GUN AT ANYONE, EVEN IF UNLOADED.*
- 3 *NEVER LEAVE A RIFLE UNATTENDED WHEN COCKED OR LOADED.*
- 4 *ALWAYS BE SURE OF WHAT LIES BEYOND YOUR TARGET.*
- 5 *ALWAYS CONDUCT YOURSELF IN A SPORTSMAN LIKE MANNER.*
6. *ALWAYS KEEP YOUR FINGER OFF THE TRIGGER UNTIL YOU ARE READY TO FIRE.*

ALWAYS BE AWARE THAT YOUR ACTIONS WILL BE UNDER THE SCRUTINY OF OTHER MEMBERS OF THE PUBLIC WHO MAY NOT SHARE YOUR ENTHUSIASM FOR AIR GUNS. BAD PRACTICES PROMOTE BAD PUBLICITY. DO NOT JEOPARDISE OUR FUTURE ENJOYMENT BY MISUSING THIS GUN.

WARNING! - UNAUTHORISED DISASSEMBLY OF THIS RIFLE WILL INVALIDATE THE MANUFACTURERS WARRANTY.

THIS AIRGUN IS INTENDED FOR USE BY THOSE 18 YEARS OF AGE OR OLDER.



WARNING!

Not a toy. Adult supervision required. Misuse or careless use may cause serious injury or death. May be dangerous up to 1,000 yards.



WARNING!

Do not inhale dust from lead pellets or put lead pellets in the mouth. Wash hands after handling lead. Lead pellets contain lead, a chemical known to the State of California to cause cancer and birth defects (or other reproductive harm).



WARNING!

Keep the air rifle in the ON SAFE position until you're ready to shoot, then push the safety to the OFF SAFE position.



WARNING!

Keep your finger off the trigger while cocking the air rifle or with the barrel in the downward position. Failure to do so may permanently damage your air rifle. Do not shoot without a pellet in the chamber (dry fire). This may permanently damage your air rifle.



WARNING!

Use the correct pellet size according to your Air Arms rifle model. Never reuse pellets. The use of any other kind of ammunition can cause injury to you or damage to the air rifle.



WARNING!

Do not assume that the gun is unloaded if it fails to fire properly!



WARNING!

Never leave your gun loaded. Do not store it loaded.

Contents of box.

1	x	Rifle.	
1	x	Set of sights.	
1	x	Tool kit consisting of.	1 x 1.5mm Allen key. 1 x 2mm Allen key. 1 x 2.5mm Allen key. 1 x 3mm Allen key. 1 x 4mm Allen key. 1 x 5mm Allen key. 1 x 6mm Allen key. 1 x Filling adaptor. 1 x Cylinder removal spanner.
1	x	Manual.	

Contents.

Important information.
Assembly.
Sight assembly.
Filling instructions.
Cocking.
Loading.
Trigger adjustment.
Stock adjustment.
Maintenance.
Parts list and diagrams.

IMPORTANT INFORMATION, PLEASE READ

Before leaving the factory this rifle was quality inspected and test fired using Air Arms PELLETS to check operation and final adjustment.

It was dispatched in a sealed purpose designed box with a contents label on the lid. Air Arms may not be responsible for any damage to the contents or missing items if the box is not original, if it is damaged or the seals are not intact.

Air Arms cannot be held responsible for damage or missing items due to transit damage, mishandling or being tampered with after leaving the factory.

If this rifle is not received in the original box with the seals intact, please examine carefully for any damage, missing tools or documentation.

In the first instance any problems or complaints regarding this product should be referred to the supplier.

The air cylinder is a highly pressurized unit that must **not** be modified in any way. Serious personal injury may result if this, and the advice below is not followed.

Do **not** pressurize the cylinder if there are any surface abrasions or dents. Contact Air Arms for advice.

Do **not** store the rifle in places with, or near sources of high temperature such as fires or boilers.

Do **not** attempt to dismantle when pressurized.

Do **not** pressurize beyond the stated filling pressure (see filling instruction section). Damage caused by such action is **not** covered by the manufacturers warranty.

Important Information continued.

Only use clean, filtered and dry compressed air. **Never** use any other gas, particularly industrial or welding gases such as oxygen, carbon dioxide, acetylene, hydrogen, argon, etc.

If compressed air is being used other than from a diving shop, the inside of the cylinder should be inspected for corrosion at least annually.

In any event the cylinder should be inspected every two to three years depending upon usage. Air Arms can provide this service at a reasonable cost.

To maintain this rifle in good working order it should be serviced annually by a competent gunsmith, your supplier may be able to provide this service or you should contact Air Arms.

A reasonable amount of advice will be provided to enable the end user to service their own rifle, however this is at the discretion of Air Arms and advice may not be given in all cases.

Due to the nature of hand pumps and their relative inefficiency in removing moisture from the air compressed air, the chances of corrosion damage to the cylinder and other internal components are increased. The rifle should be regularly serviced and/or checked for any signs of damage by a competent gunsmith.

Air Arms recommend using a dry pack filter kit on any hand pump used to fill our air rifles.

Air Arms cannot be held responsible for the loss of performance when accessories used that are not manufactured by Air Arms. Contact your supplier or Air Arms for any advice on this matter.

Do **not** store the rifle in a damp place such as a garden shed or garage.

Do **not** store this rifle in a plastic or PVC gun bag without first applying a surfaces corrosion inhibitor.

Always ensure the loading bolt is fully closed before firing.

***** LIMITED LIABILITY WARRANTY ***** UK Customers only.

This product is warranted to the retail customer for 12 months from the date of purchase against defects in materials and workmanship and is transferable to any subsequent owner.

Proof of purchase is required to receive warranty repairs, retain your purchase invoice and return the warranty registration card as soon as possible after purchase. The warranty card must show the dealer/supplier name and address and date of purchase.

What is covered.

Replacement parts & labour on a 'back to base' basis, return transportation to the consumer (mainland UK only).

What is not covered.

Transportation from the consumer to Air Arms.

Damage caused by misuse, abuse, lack of routine maintenance, transit damage between the dealer/supplier and the consumer.

Unauthorised disassembly.

Parts subject to normal wear and tear.

Any other consequential cost incurred by the consumer.

Return transportation to consumers outside the mainland UK.

No warranty is implied as to the fitness for any particular purpose.

AIR ARMS RESERVE THE RIGHT TO ALTER THE CONSTRUCTION, APPEARANCE OR PERFORMANCE OF ANY PRODUCT WITHOUT PRIOR NOTIFICATION. ALL ILLUSTRATIONS ARE FOR INFORMATION PURPOSES ONLY AND DO NOT NECESSARILY SHOW THE EXACT MODEL THAT WAS PURCHASED.

Assembly and Disassembly of the rifle.

One of the features of the S400 Biathlon Rifle is the fact that the rear butt stock can be removed from the fore-end to allow a change of handing i.e. right hand to left hand.

This is achieved by removing the bolt (turning counter-clockwise) from the bottom of the pistol grip area with the 6mm Allen key supplied with the rifle. Once the screw has been removed the two halves of the stock can be gently pulled apart. Re-assembly is the reverse procedure.

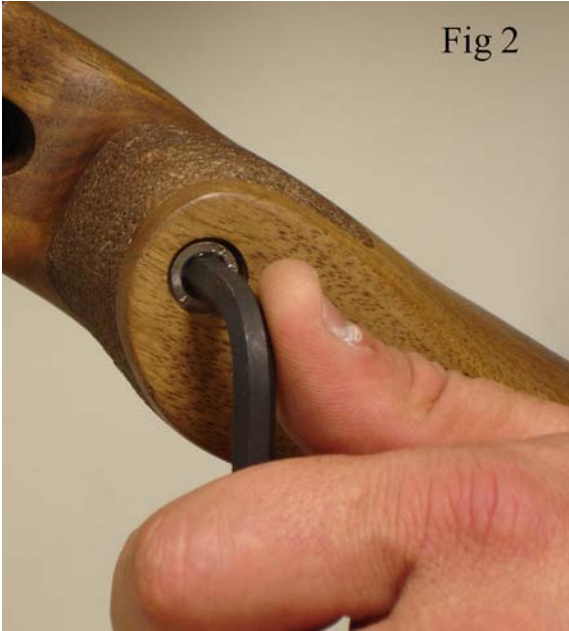

Sight assembly.

If you wish to use the sights supplied with your Biathlon Rifle they first have to be fitted to the gun.

The set of sights supplied comes in 2 pieces, Fig 5, the front sight and rear sight, and both fit onto dovetail mountings on the rifle.

Firstly making sure that the thumb screw is loose, slide the rear sight onto the dovetails and into position Fig 6. Once the sight is in position, the thumb screw can be tightened, being careful not to over-tighten the screw Fig 7. When the sight is on the dovetail it can be moved forwards and backwards to establish the proper eye relief for each position.

If not already fitted, fit the riser block to the bottom of the front sight Fig 8. **Note:** If the riser block is not fitted on the barrel the rifle cannot be properly sighted in.

The sight can now be fitted into the dovetails on the muzzle Fig 9.

The sight tunnel should be fitted with the screw on the left side facing the rear of the gun. When in place the screw can be tightened Fig 10, **care must be taken as the screw and nut are mounted into the plastic moulding and over tightening will damage the sight.**

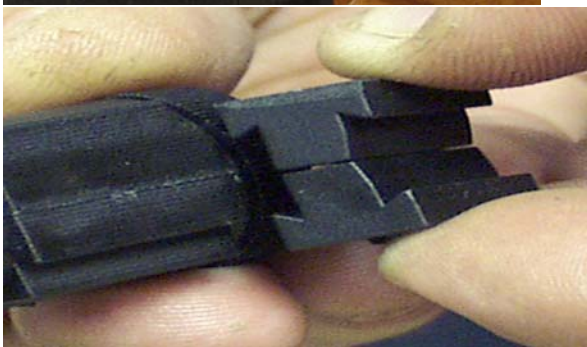
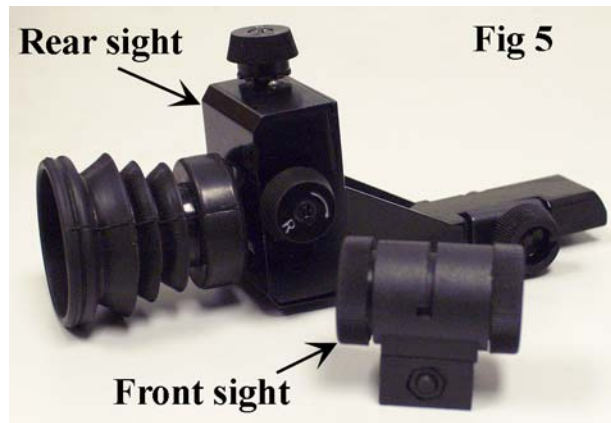

Filling the Cylinder.

Removing the cylinder from the rifle.

To fill the cylinder it must first be removed from the main body of the rifle. This is achieved by unscrewing the cylinder in a anticlockwise direction. Fig 11. The cylinder should only be hand tight, if this is not the case use the spanner provided to loosen the cylinder, then continue without the spanner Fig 12.

Note. When removing the cylinder from the rifle there may be a sound of air escaping, this is normal. Unscrew the cylinder enough to allow the air seal to break, wait for the release of air to stop then unscrew the cylinder the rest of the way.

Once the cylinder has been completely unscrewed remove it from the rifle.



Filling adaptor.

Fit the filling adaptor supplied to your chosen filling kit i.e. scuba bottle or pump. This simply screws in and seals down on the O ring in the adaptor.

With the adaptor, Fig 13, attached to your filling kit, screw the end of the cylinder into the adaptor. Close the bleed valve on the adaptor. Fig 14, and **slowly** open the main valve on the filling bottle or start pumping. When the air in the hose equalizes with the air in the cylinder, the cylinder will start to fill. Continue to **slowly** fill the cylinder until the required pressure of **200bar** is reached. **Note.** Always use the **gauge on the filling equipment and not on the rifle.**



Fig 14



Once the desired pressure is reached close the main valve on the filling bottle or stop pumping. Open the bleed valve on the adaptor, this will vent the trapped air in the hose and allow the cylinder to be unscrewed from the adaptor. If you don't vent the adaptor, air trapped in the hoses makes removing the cylinder from the filling kit very difficult and may cause damage to the adaptor seals.

With the vent screw open unscrew the cylinder from the filling adaptor.

Cock the action (this is to make sure the firing valve is closed to stop air venting down the barrel) and screw the cylinder back onto the rifle. The cylinder should be hand tight.

DO NOT USE THE SPANNER TO TIGHTEN THE CYLINDER ONTO THE RIFLE.

REMEMBER THE RIFLE IS NOW IN A COCKED STATE AND READY TO FIRE, IT SHOULD NOW BE DE-COCKED OR FIRED OFF.

Note. The threads of the cylinder and cylinder extension, (where the cylinder screws into the rifle) must be protected and kept free of grit or dust. A thin coating of grease, such as Napier VP90 gun grease, may be applied to reduce friction on the threads.

It is also recommend that the cylinder pressure be allowed to fall to 100bar-110bar before removing to fill. Although this is not critical it will make the removal of the cylinder to refill easier.

Note on pumps.

If you are going to use a pump as your filling kit you will also need the pump adaptor, Fig 15, available from Air Arms. Order reference. Z2128-300.

Air Arms recommend that pump usage instructions are closely followed so as not to damage the cylinder of the rifle.

Also available for the HILLS pump is a drypac filter kit which will remove most of the moisture in the atmosphere.

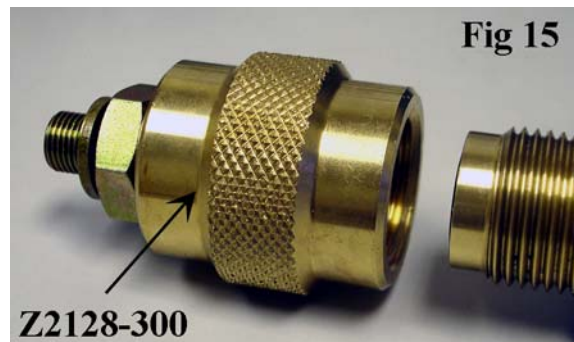

The in Stock Magazine Clips

On the right hand side of the stock are the magazine clips. The magazines simply push into the clips as in the picture below.



Cocking and Loading the rifle.

To cock the S400 Biathlon rifle hold the gun firmly in one hand and with the other hook the index and middle finger around the handle and pull the lever all the way to the back as far as it can travel. See below.



MOUNTING/DEMOUNTING THE MAGAZINE & PELLETS

DEMOUNTING

Fully cock the rifle, grip the magazine as shown below and slide out of the bolt housing without lifting. Do not attempt to lift vertically as damage to the indexing spring will result.

To refit the magazine, fully cock the rifle, grip the magazine in the same fashion and reverse the process sliding the magazine into the bolt housing applying downward pressure with the fore finger to keep the base of the magazine against the bottom of the slot in the bolt housing. Take care not to damage the indexing spring.



LOADING PELLETS

Hold the magazine as in fig.3 and drop a pellet into the chamber. Manually index to the next empty chamber as in fig.4 and repeat until the magazine is full.

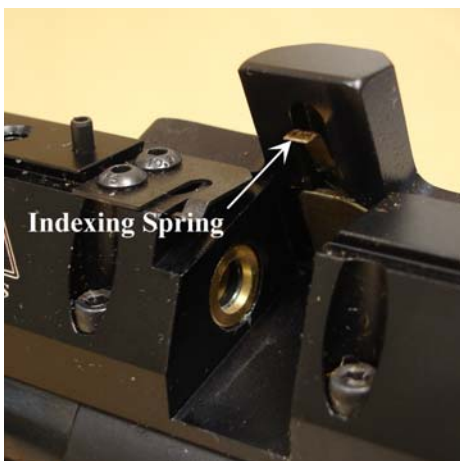
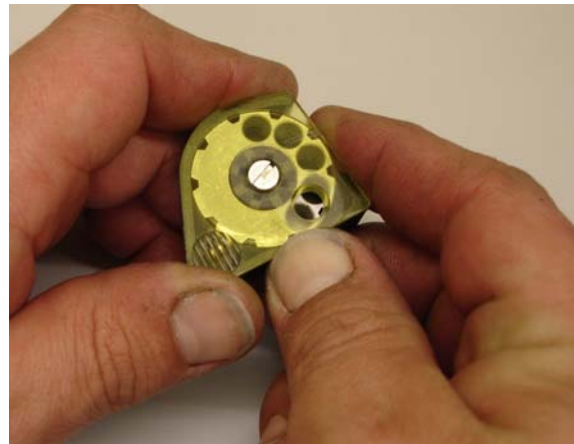

Be very careful not to damage the indexing spring when demounting or mounting the magazine. Follow the instructions carefully.

WARNING. *The rifle should only be fired when the magazine is fitted in the breech or damage to the seal carrier may occur.*

Trigger adjustment.

The Biathlon Rifle has a two stage trigger. This means that as the trigger is pulled the bottom sear gradually disengages with the top sear until the two disengage completely and the rifle fires. If the pressure on the trigger is released before firing, the sears return to their first fully engaged position. This type of trigger allows a very fine but safe operation because it is the release of the second stage that actually fires the gun. This arrangement is vastly superior to single stage trigger, however it must be stated that adjustment of a two stage unit is more difficult than the adjustment of a single stage trigger.

Trigger positioning.

The trigger on the Biathlon Rifle can be adjusted in a variety of ways to make the trigger as efficient as possible. First, the trigger blade can be rotated around the trigger pillar, this allows the finger to sit perfectly on the trigger.

The blade can be raised or lower on the pillar to make sure that it is in line with the shooters finger.

The whole trigger blade and pillar assembly can also slide forwards and backwards along the trigger bar to increase or decrease the length of pull.

These adjustments will allow the gun to be tailored the individual shooter.

Fig 20.

- A - Pillar screw.
- B - Blade screw.
- C - Second stage adjuster.
- D - First stage adjuster.
- E - Weight of pull adjuster.
- F - Trigger bar.
- G - Trigger blade.
- H - Trigger pillar.

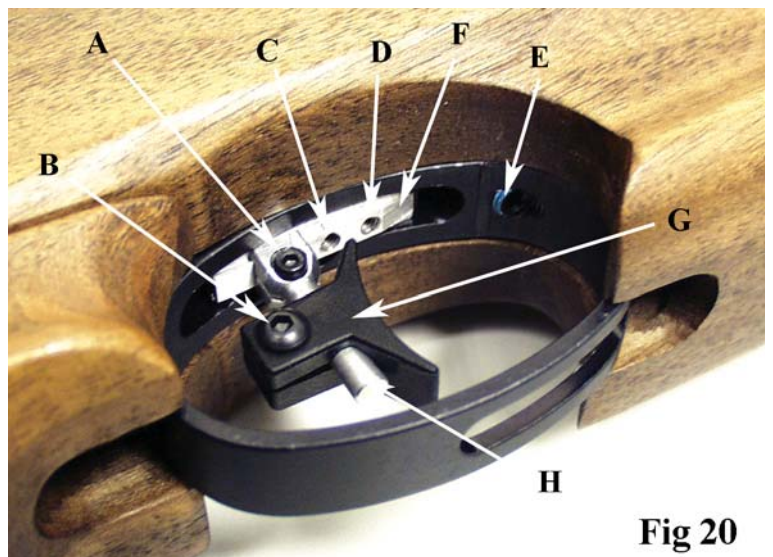

Fig 20

Rotating, raising and lowering the blade.

The trigger blade can be rotated and moved up and down on the trigger pillar by loosening the screw in the blade 'B' (use the 2mm Allen key supplied.) Fig 21.

Once in position the screw can be re-tightened.

WARNING. Over tightening screws or bolts mounted into plastic may cause damage.

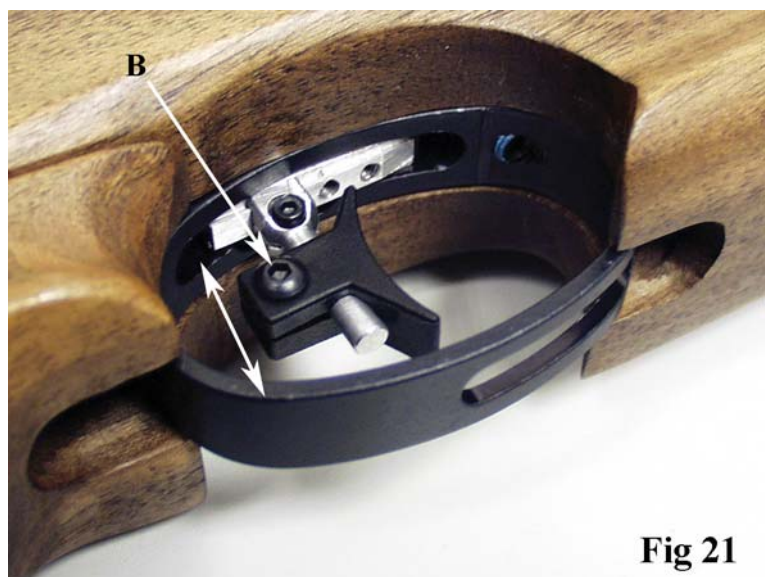

Fig 21

Moving the pillar on the trigger bar.

Loosening screw 'A' with the 1.5mm Allen key (supplied) will allow the trigger pillar to be moved forwards and backwards along the trigger bar. (Fig 22).

Trigger adjustment.

The operation of the trigger is controlled by 3 screws C, D & E (fig 23).

The weight of pull adjustment is controlled by screw 'E', and is located in front of the trigger, housed in the trigger guard (fig 20).

Clockwise rotation will increase the pull weight and counter-clockwise will decrease the weight. If the screw is over adjusted in the clockwise direction the spring will become coil-bound and may prevent operation of the trigger.

The first stage adjuster 'D' is the first screw in the trigger bar looking from the front of the gun (fig 23). This screw determines the length of first stage travel before the second stage engages. Clockwise adjustment reduces the first stage travel.

The second stage adjuster 'C' is located next to the first stage screw (fig 23). This screw determines the exact pull-off point of the trigger.



Fig 22

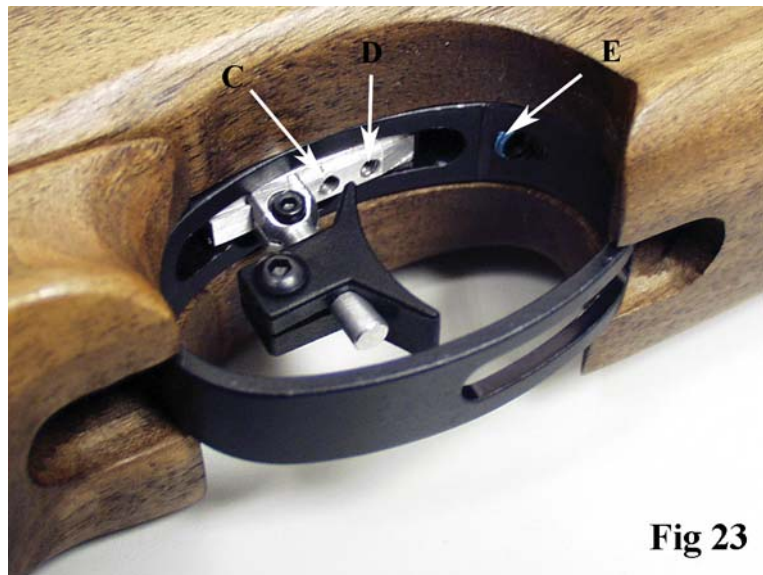

Fig 23

WARNING. Adjustment of a two-stage trigger can be difficult and should be left to experienced and trained technicians. Adjustment to any one of the screws will have a direct effect on the other two screws and could make the gun unsafe.

If you have no experience of adjusting a two-stage trigger it is highly recommended that you seek guidance or leave the trigger on the factory settings.

Tip.

When adjusting the trigger write down on a piece of paper the number of turns and direction of each adjuster screw. This will make it easier to recover the original settings if required.

Adjusting the Cheek Piece and Butt Pad.

The cheek piece can be adjusted in two planes first it can be raised and lowered by loosening screw 'J' (fig 25). The cheek piece can also be adjusted a small amount from side to side as in (fig 25), by loosening screws 'I'.

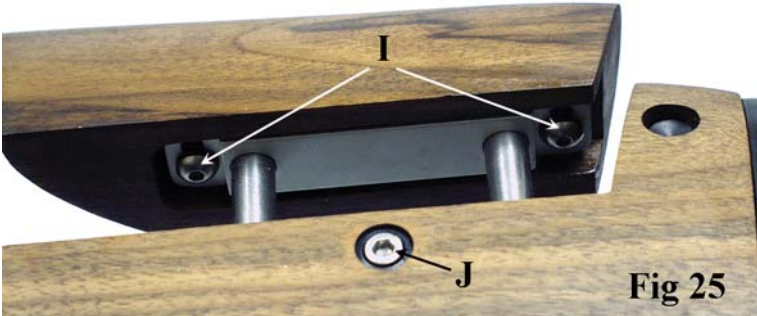

Adjusting butt pad.

The butt pad on the rifle can be adjusting in the vertical plane by loosening screw 'K', and sliding the pad into position then re-tightening screw 'K'. Fig 28.

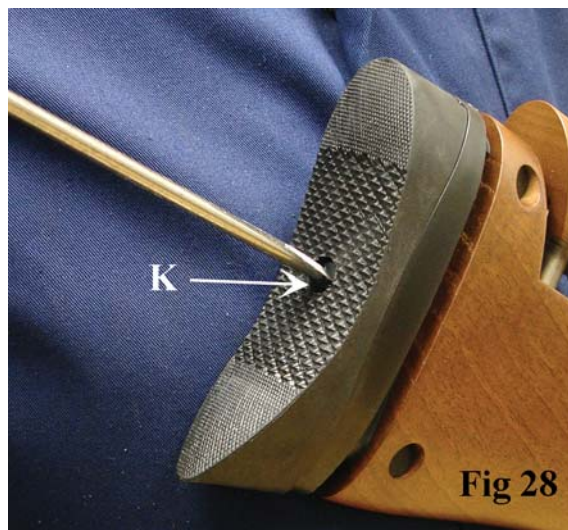

Spacers can be added in between the butt pad assembly and the butt stock to lengthen the stock. This can be achieved by moving the rubber pad up or down to expose screw 'L', Fig 29 at the top and bottom of the butt pad assembly.

Loosening these screw will allow a spacer (available from Air Arms) to be place into the assembly.

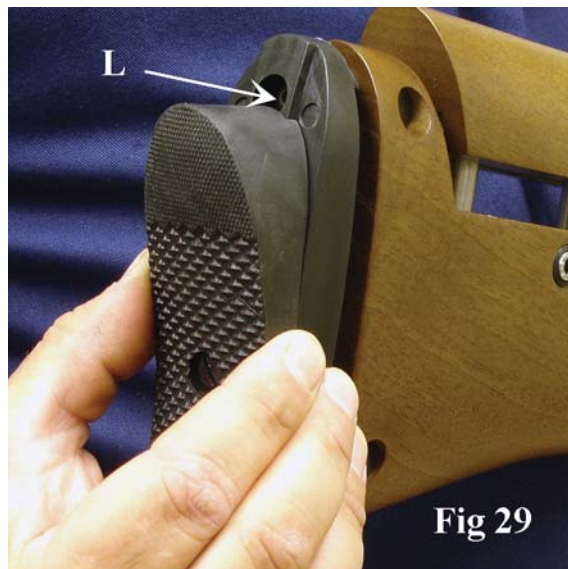

MAINTENANCE

FIXINGS

Regularly check the tightness of all fixings. However do **not** be tempted to over tighten as some parts are made from aluminium and stripped threads may result. Stripped threads are not covered by the manufacturers warranty.

BARREL

For ultimate accuracy, clean and re-lube the barrel frequently. It is difficult to advise how often is best for every circumstance, but every 250 shots is not too often if the desire is to keep the barrel in the best possible condition.

The correct materials are very important. Air arms only uses products made by napier. Listed below is the napier product and a more generally available alternative. If possible use napier for the best results.

CLEANER :	'NAPIER GUN CLEANER', ALTERNATIVELY WHITE SPIRIT.
OIL :	'NAPIER GUN OIL', ALTERNATIVELY '3 IN 1' OIL.
PULL-THROUGH PAD:	'NAPIER RIFLE CLEAN', ALTERNATIVELY SOFT COTTON CLOTH.
PULL-THROUGH LINE:	'NAPIER PULL THROUGH KIT', ALTERNATIVELY 20lb FISHING LINE.

As a rule cleaners and oils intended for shotguns and small/fullbore weapons are not suitable.

- 1> Cut a piece of line three times the length of your barrel, fold in half and tie ends together. Remove silencer if fitted. Open loading bolt.
- 2> Feed un-knotted end down barrel from the muzzle end until folded end protrudes about 50mm.
- 3> Cut a 100mm length of 'rifle clean' or 100x50mm piece of cloth and pass it between the protruding loop. Spray the pad with 'gun cleaner' or white spirit, turn the rifle upside down and pull the line back through the barrel slowly.
- 4> Repeat steps 2&3 until the pad is clean.
- 5> Repeat steps 2&3 once more without any cleaner on the pad to dry the barrel.
- 6> Repeat steps 2&3 once more with the pad sprayed with 'gun oil' or 3 in 1 oil.

IMPORTANT : THE REASON FOR TURNING THE RIFLE UPSIDE DOWN IS TO PREVENT EXCESS CLEANER/OIL FROM PASSING DOWN THE TRANSFER PORT INTO THE FIRING VALVE CHAMBER.

LUBRICATION

Lubrication of the internal mechanism is not covered in this handbook. This is best performed by a competent gunsmith or the factory and in any case should not be required until the annual service.

On return from every shooting session, wipe all over the exterior with an oily rag to preserve the surface finish during storage.

SAFETY

You and others with you should always wear shooting glasses to protect your eyes.

Always aim your air rifle in a **SAFE DIRECTION**. When you are sure of your target and backstop and the area around the target is clear, take the air rifle **OFF SAFE** and squeeze the trigger to fire.

Do not shoot at hard surfaces or at the surface of water. The pellet may bounce off or ricochet and hit someone or something you had not intended to hit.

Always choose your target carefully. It is best to shoot at paper bullseye targets attached to a safe backstop. Your backstop should be checked for wear before and after each use. Replace your backstop if the surface is worn or damaged or if a ricochet occurs.

Your rifle is suited for indoor and outdoor use. Always remember to place your target carefully. **THINK** about what you will hit if you miss the target.

Do not attempt to disassemble or tamper with your air rifle. Contact Air Venturi at 216-292-2570 for repair.

Do not put the air rifle away while it is loaded or cocked.

REPAIR SERVICE

**If your rifle needs to be repaired,
contact Air Venturi at 216-292-2570.**

ITEM NO.	PART NUMBER	DESCRIPTION	QTY.	ITEM NO.	PART NUMBER	DESCRIPTION	QTY.
1	JT500-SL	BOLT HSE - SIDE LEVER	1	38	S306	FIRING VALVE SPRING	1
2	S540A - SL	.177 LOADING BOLT STEM - SIDE LEVER	1	39	JT360	FIRING VALVE SPRING RETAINER	1
3	S140	LOADING BOLT DETENT BUFFER . 22	1	40	S471	SINTERED FILTER	1
4	S501 - SL	BOLT HSE BUSH .22 - SL	1	41	JT337	CYL EXT INSERT	1
5	S130	COCKING ARM PIVOT BLOCK	1	42	E146	COCKING ARM FRICTION PAD	1
6	S322	M3x12 CSK SOC	1	43	TX228	M4 x 4 SKT SET FL PT	1
7	JT340	M3 x 20 CSK SKT	2	44	S303	M3 x 4 SKT SET FL PT	2
8	TX435	M5 x 16 CSK SKT	2	45	JT336-1	CYLINDER EXTENSION	1
9	JT125-B	COCKING ARM BI ATHLON	1	46	JT338	CYLINDER EXTENSION O RING	1
10	E144	3x23.8 PIN	1	47	JT336-2	GLAND NUT	1
11	S541-1	BEARING SHIM	1	48	S340	STRIKER ROD	1
12	S541	BEARING	1	49	JT520-SL	STRIKER - SIDE LEVER	1
13	S542	SIDE LEVER BUSH	1	50	S520-1	BUSH	2
14	S264	COCKING LINK	1	51	JT331	MAIN SPRING	1
15	E127	3x11.8 Roller	1	52	S356H	STRIKER SCREW	1
16	S355H-SL	M4x16 TURNED HEAD	1	53	JT530	REAR SPRING GUIDE 7 JOULE	1
17	S550	SIDE PLATE	1	54	TRIGGER ASSY - BI ATHLON	TRIGGER ASSY - BI ATHLON	1
18	S515A	INDEXING POST	1	57	JT380-SL	BARREL CLAMP - SIDE LEVER	1
19	S565	M3 x 8 SKT CAP	3	58	JT442	MAGAZINE RAIL	1
20	RN102A	M3 x 16 SKT CAP	4	59	KS631	MAGAZINE CLIP	4
21	TX236	M4 x 16 SKT CAP	2	60	JT445	M4 x 5 CH HD	8
22	RN135	M6 x 12 SKT CAP	1	62	KS445	No 6 3/8" POZI CSK	5
23	S303	M3x4 FLAT POINT	2	63	RN445	No 6 1 1/4" POZI CSK	2
24	E160	M3 CRINKLE WASHER	2	64	JT440	ACCESSORY RAIL	1
25	S427	6x1 O RING	1	77	S655	6 X 12 X 1.5 WASHER	1
26	JT228	M4x5 CONE POINT	3	78	JT125-1	COCKING LEVER HANDLE	1
27	S505	MAG RETAINING CLIP	1	79	RN106	M3 x 6 CSK SLOTTED	1
28	RN193	M3 x 6 SKT BTN HD	2	80	S558	.177 MAGAZINE - 5 SHOT	4
29	S680	M3 x 4 BT HD	1	81	S625	M6 x 40 SKT CAP	1
31	JT112	BARREL	1	84	JT101	3 x 14 DIN 6325	1
32	FP121	4.5x1.5 NBR70	1				
33	JT459S-B	MUZZLE END (SHORT) - BI ATHLON	1				
34	JT507-SL	FIRING VALVE BODY - SIDE LEVER	1				
35	rn234	BS213 O RING	1				
36	RN191	ADJUSTER SCREW	1				
37	S370	FIRING VALVE ASSY	1				

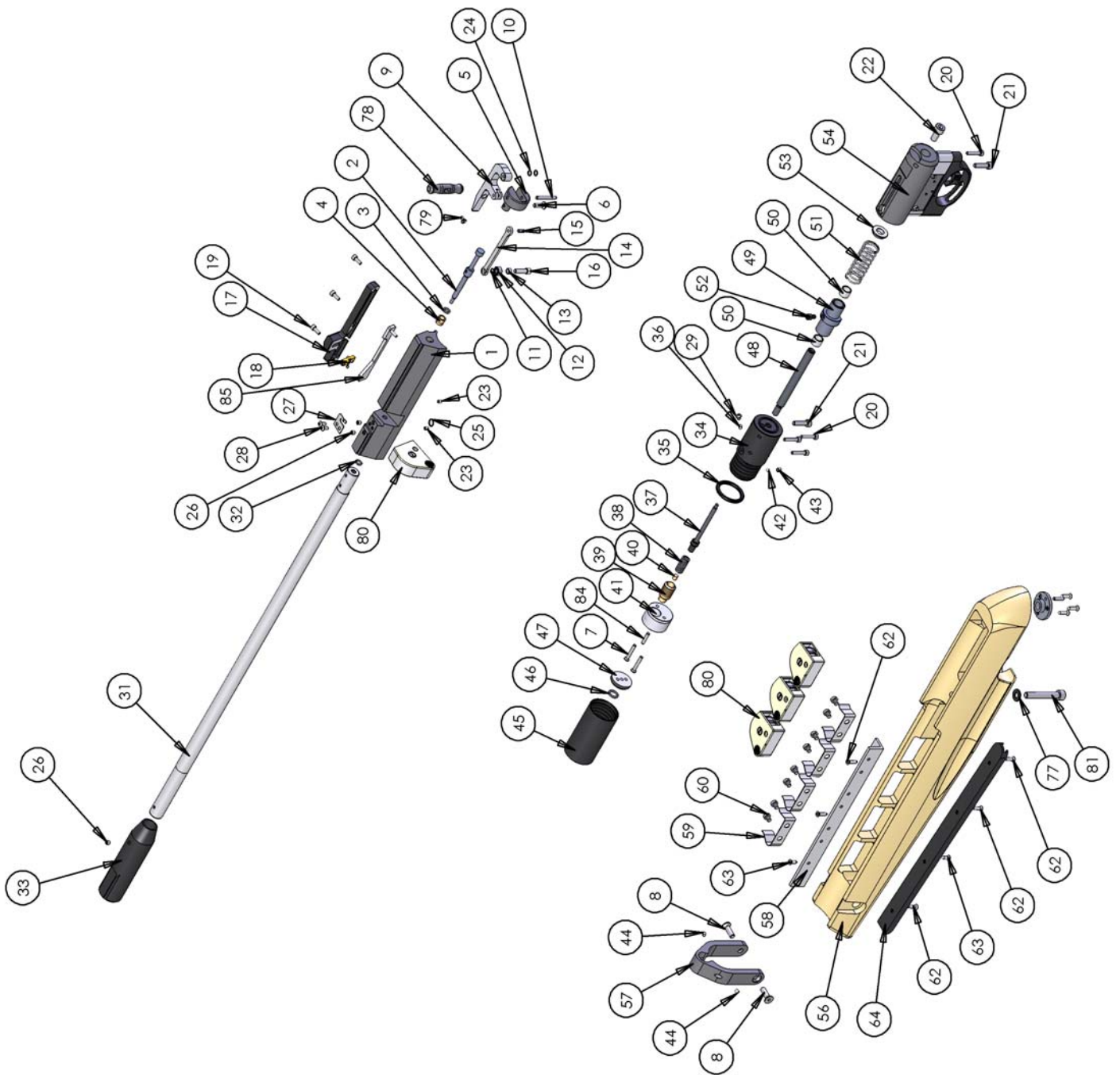

PART LIST <> BUTT ASSEMBLY

PART NO.	DESCRIPTION.	QTY	PART NO.	DESCRIPTION.	QTY
JT450C	CHEEK PIECE	1	RN405	BOTTOM PLATE	1
RN400	TOP PLATE	1	RN420	SCREW	1
RN430	SCREW	2	RN425	BUSH	1
RN410FT	PILLAR	2	RN435	SCREW	2
KS445	SCREW	3	CZ080	BUTT ASSEMBLY	1
JT455-1	JOINT PIECE	1	JT450B	BUTT STOCK	1
RN415	LOCKING PLATE	1			

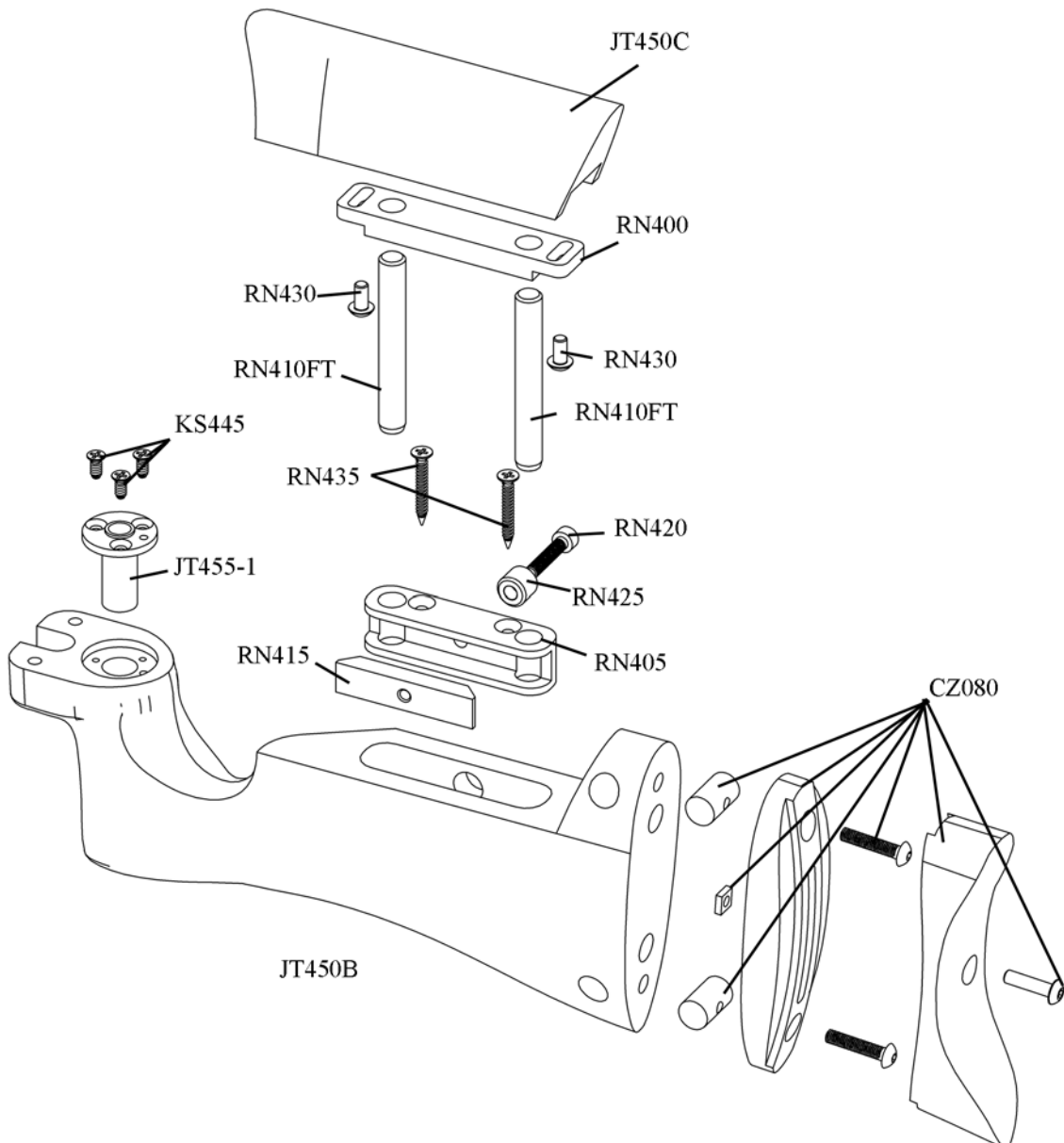

PART LIST <> METAL BUTT ASSEMBLY

PART NO.	DESCRIPTION.	QTY	PART NO.	DESCRIPTION.	QTY
CZ078	NUT	2	JT450B	BUTT STOCK	1
E410	ADJUSTER RODS	2	JT450C	CHEEK PIECE	1
E455	SLIDER	1	JT455-1	JJOINT PIECE	1
E455-1	TOP ARM	1	KS445	SCREW	3
E455-2	BOTTOM ARM	1	RN400	TOP PLATE	1
E457	SWIVEL PLATE	1	RN405	BOTTOM PLATE	1
E457-2	BACKING PLATE	1	RN410FT	CHEEK PIECE PILLARS	2
E462	LOCKING PLATE	1	RN415	LOCKING PLATE	1
E471	NUT	2	RN420	SCREW	3
E476	SCREW	4	RN425	BUSH	1
E496	SCREW	2	RN430	SCREW	2
JT405	ADJUSTER MOUNT	1	RN431	WASHER	10
JT415	LOCKING PLATE	1	RN435	SCREW	2
JT416	SCREW	1	S641	SCREW	2

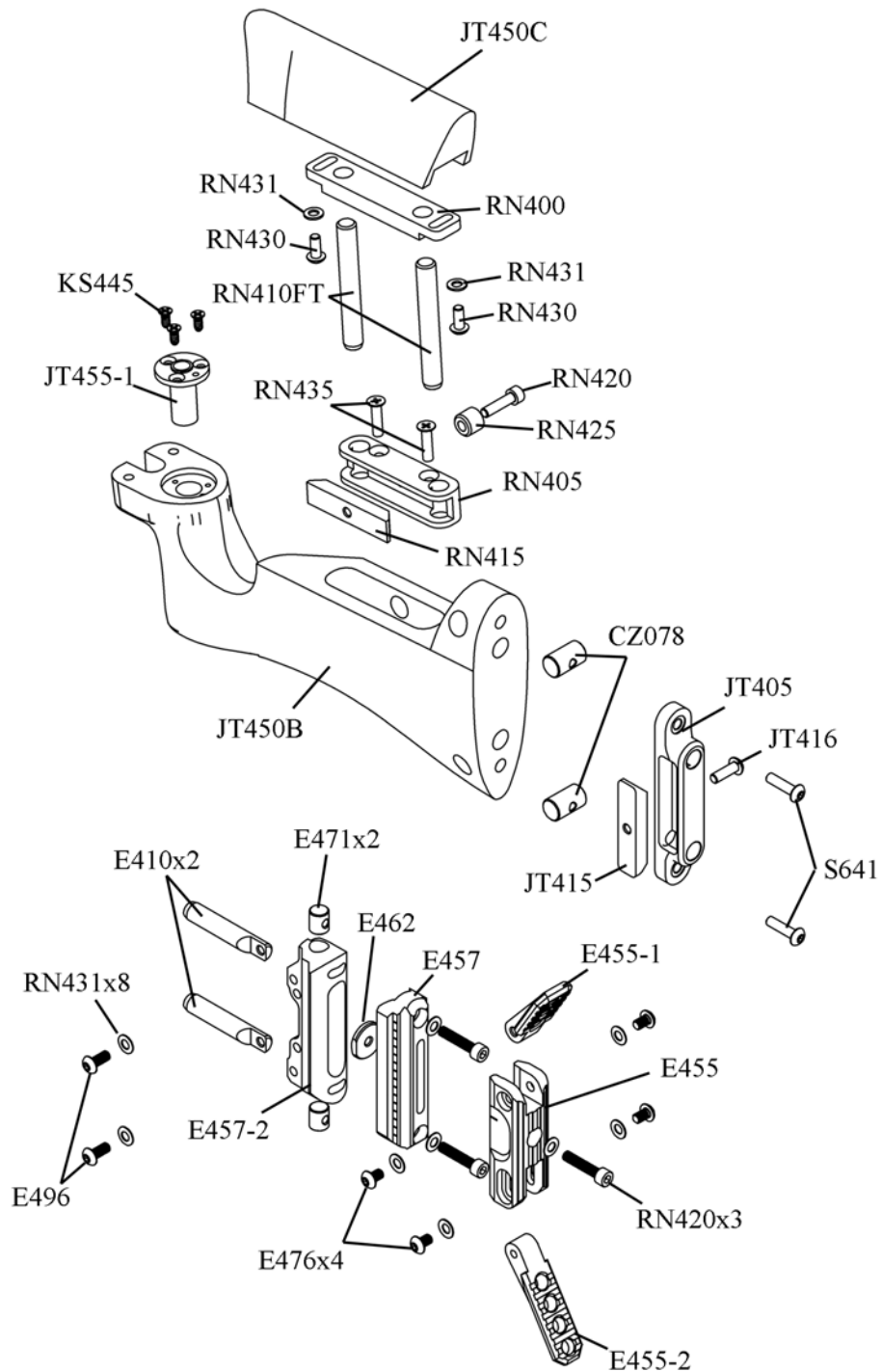

ITEM NO.	PART NUMBER	DESCRIPTION	QTY.	ITEM NO.	PART NUMBER
1	S312	TRIGGER CHASSIS	1	16	JT420
2	TX398	3x11.8 ROLLER	1	17	TX432
3	S495	TOP SEAR SPRING	1	18	S421
4	S496	M3x6 CAP	1	19	JT330
5	S322	M4x12 csk soc	1	20	BB268
6	S326	2x11.8 ROLLER	4	21	RN350
7	TX236	M4x16 CAP	1	22	RN351
8	S320-2	TOP SEAR	1	23	RN352
9	S325-2	BOTTOM SEAR	1	24	S315
10	S321-2	MIDDLE SEAR	1	25	TX381
11	S329	BS004 O RING	3	26	RN170
12	S328	BS005 O RING	1	27	S316
13	S319	WEIGHT OF PULL SPRING	1	28	TX460
14	S430	COVER PLATE	1	29	S310-SL
15	S324	M3X5 CHEESE HEAD	2		

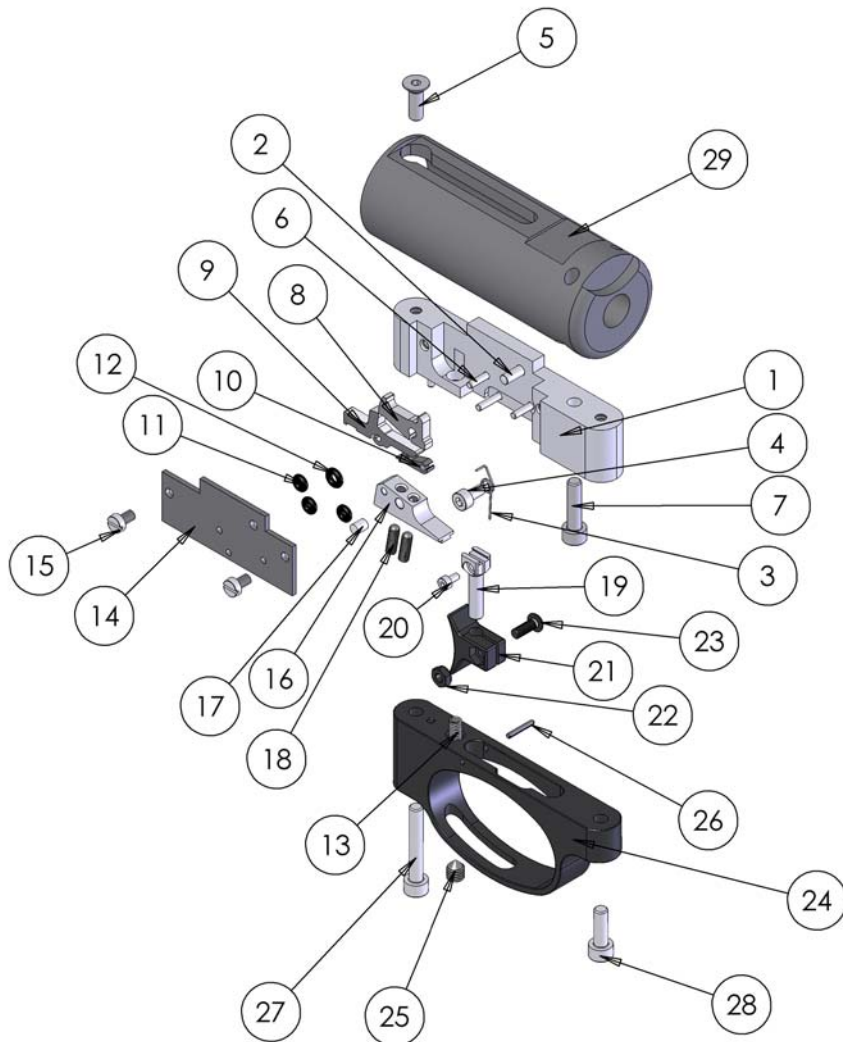

CYLINDER PART LIST

ITEM NO.	PART NUMBER	DESCRIPTION	QTY.
1	RN235	CYL TUBE	1
2	JT490	GAUGE BODY	1
3	RN234	BS213 O RING	2
4	S645	INDICATOR GAUGE	1
5	RN219-9	BS 011 O RING	1
6	RN241	20X4 O RING	1
7	JT491	FILLING VALVE BODY	1
8	JT102	BS1300-14 CIRCLIP	1
9	JT103	FILLING VALVE SPRING RET	1
10	RN239	FILLING VALVE	1

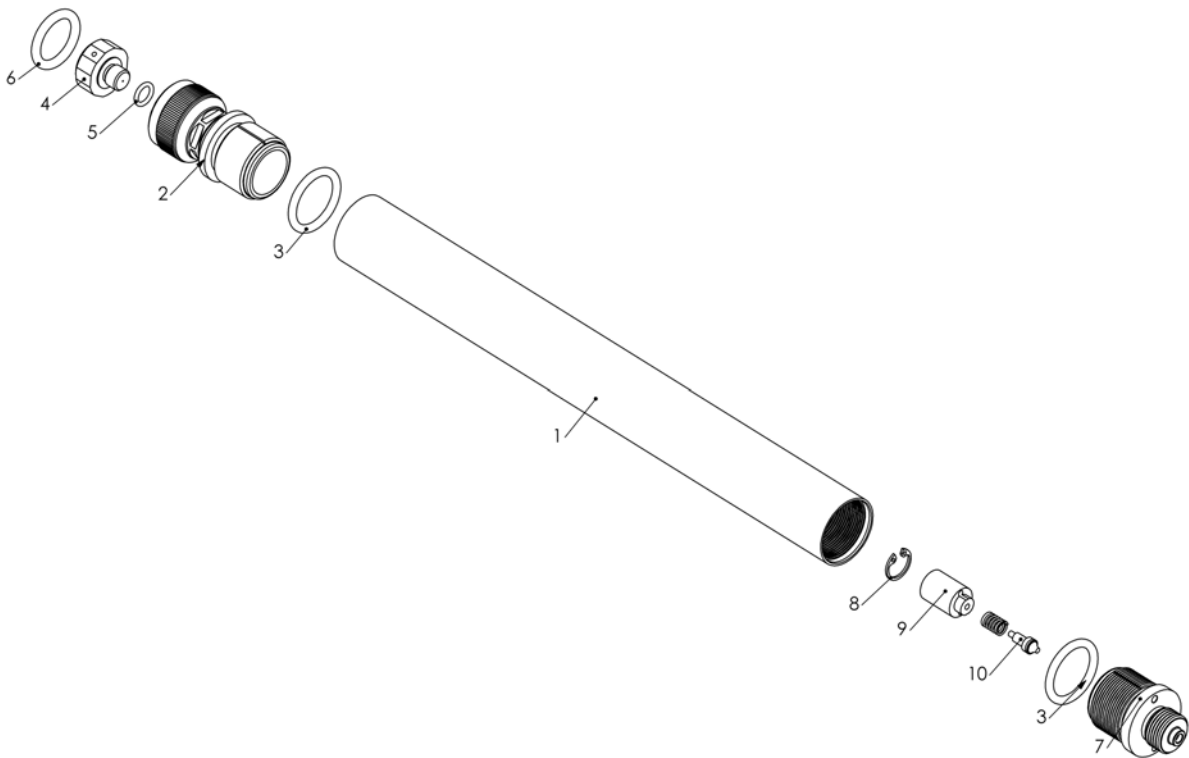

Technical Information.

Weights and measures.

Overall weight.

Sporter.	3.15kg.
Precision with rubber pad.	3.17kg.

Overall Length.

Sporter.	925mm (36 3/8").
Precision with rubber pad.	1040mm (41").

Barrel length.	480mm (18 7/8").
Barrel length including muzzle.	522mm (20 1/2").
Barrel length including long muzzle.	545mm (21 1/2").

Length of sight line.

Sporter.	645mm (25 3/8").
Precision.	760mm (29 7/8")

Length of accessory rails.

Internal (optional on sporter).	192mm (7 1/2").
External.	260mm (10 1/4").

Reach to pull.

Rubber butt pad models.	308mm - 318mm.
-------------------------	----------------

Calibre.	.177 (4.5mm)
Power.	7 joules (5.15ftlb).
	16 joules (12ftlb).

Cocking method.	Bolt action.
-----------------	--------------

WARRANTY

Limited One-Year Warranty

This product is warranted to the retail consumer for one year from date of retail purchase against defects in material and workmanship and is transferable.

What is covered:

Replacement parts and labor. Transportation charges to consumer for repaired product.

What is NOT covered:

Transportation charges to Air Venturi for defective products. Damages caused by abuse or failure to perform normal maintenance. Any other expense. CONSEQUENTIAL DAMAGES, INCIDENTAL DAMAGES OR INCIDENTAL EXPENSES INCLUDING DAMAGE TO PROPERTY. SOME STATES DO NOT ALLOW THE EXCLUSION OR LIMITATION OF INCIDENTAL OR CONSEQUENTIAL DAMAGES, SO THE ABOVE LIMITATION OR EXCLUSION MAY NOT APPLY TO YOU.

Warranty claims:

Warranty claims for U.S. and Canadian Customers:

Please return product to Air Venturi. Call Air Venturi at 216-292-2570 before returning any product.

Implied warranties:

ANY IMPLIED WARRANTIES, INCLUDING THE IMPLIED WARRANTIES OF MERCHANTABILITY AND FITNESS FOR A PARTICULAR PURPOSE, ARE LIMITED IN DURATION TO ONE YEAR FROM DATE OF RETAIL PURCHASE. SOME STATES DO NOT ALLOW LIMITATIONS ON HOW LONG AN IMPLIED WARRANTY LASTS, SO THE ABOVE LIMITATION MAY NOT APPLY TO YOU.

To the extent any provision of this warranty is prohibited by federal, state or municipal law which cannot be preempted, it shall not be applicable. This warranty gives you specific legal rights, and you may also have other rights which vary from state to state and country to country.

Air Venturi

AirVenturi.com • 216-292-2570



WARNING!

DO NOT TRY TO DISASSEMBLE THE GUN. Your rifle needs special tools and Air Arms parts in order to be repaired. If you disassemble it, you may not be able to properly reassemble it. Air Arms does not assume any warranty liability under such circumstances.

Notes.