



10 SHOOTING SAFETY RULES

! WARNING: FAILURE TO FOLLOW THESE RULES CAN RESULT IN SERIOUS INJURY OR DEATH.

1

Always keep the muzzle pointed in a safe direction.

There are several safe "carries" depending on the situation.

NEVER ALLOW THE MUZZLE TO POINT IN THE DIRECTION OF A PERSON.

2

Treat every gun as if it were loaded.

You can never be positive that you were the last person to handle the gun. Never take anyone's word about whether or not a gun is loaded. Always check a gun to see if it is loaded when removed from storage or received from another person. Even if you have

fired an airgun one or more times and no pellet or BB was expelled from the barrel, it does not mean that the magazine of the gun is empty of ammunition. Any airgun can fail to feed for any number of reasons. Continue to treat the airgun as loaded and ready to fire. **ALWAYS TREAT A GUN AS IF IT IS LOADED EVEN IF YOU KNOW IT ISN'T.**

3

Only load or cock a gun when you are shooting.

A loaded gun has no place in your home or other public place.

4

Check your target and beyond your target.

Be sure all persons are well clear of the target area before you shoot. Check behind and beyond your target to be certain you have a safe backstop and that no person or property could be endangered.

5

Anyone shooting or near a shooter should wear shooting glasses.

Also, all other persons should remain behind the shooter.

6

Never climb or jump with a gun.

You can't control the direction of the muzzle if you stumble or fall.

You should safely lay the gun down or hand it to a companion while you climb or jump over anything.

7

Avoid ricochet.

Never shoot at a flat hard surface or at the surface of water. Ammunition can ricochet off of water just like a skipped rock.

8

Keep the muzzle clear.

Never let anything obstruct the muzzle of a gun. Don't allow the muzzle to come in contact with the ground.

9

Guns not in use should always be unloaded.

Keeping guns unloaded when not in use is critical to the safety of you and others. When you are finished shooting, put the trigger safety in the "on" position and unload the gun. Store guns so that they are inaccessible to untrained shooters and store ammunition separately from the gun.

10

Respect other people's property.

Whether you're target shooting or hunting, if you're a guest on others' land, you should leave it exactly as you found it.

Visit www.daisy.com and read the shooting safety rules. Take a quiz and get your "Take Aim at Safety" Certificate.

Daisy
TAKE PRIDE. IT'S A DAISY.

Daisy Outdoor Products

Rogers, AR 72757-0220 U.S.A.
800-643-3458 • www.daisy.com

OPERATION MANUAL

POWERLINE[®]

BY **Daisy**[®]

MULTI-PUMP PNEUMATIC AIR RIFLES

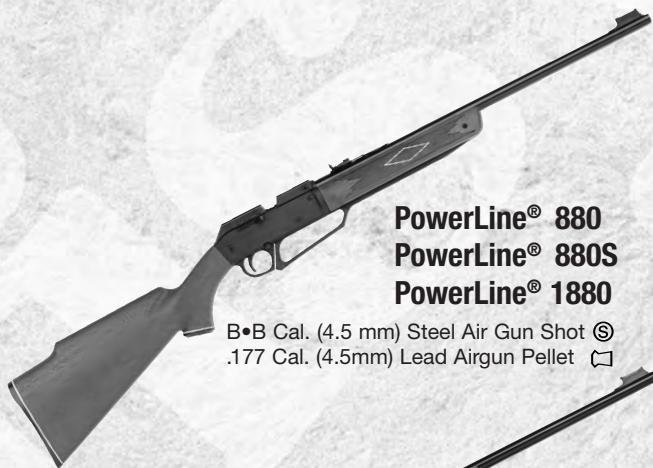

PowerLine[®] 880
PowerLine[®] 880S
PowerLine[®] 1880

B•B Cal. (4.5 mm) Steel Air Gun Shot ☉
.177 Cal. (4.5mm) Lead Airgun Pellet ☐

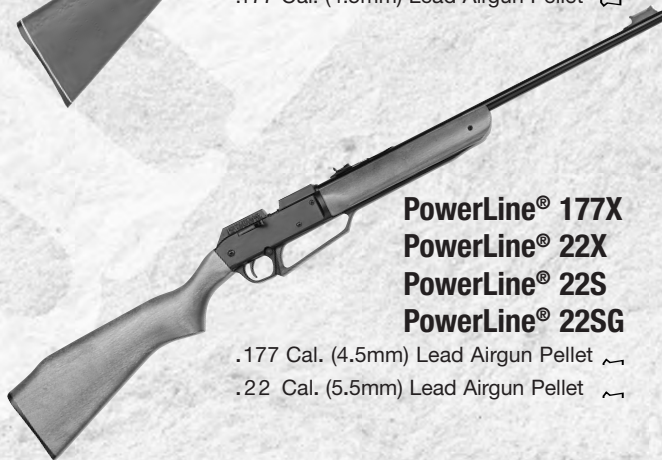

PowerLine[®] 177X
PowerLine[®] 22X
PowerLine[®] 22S
PowerLine[®] 22SG

.177 Cal. (4.5mm) Lead Airgun Pellet ~
.22 Cal. (5.5mm) Lead Airgun Pellet ~

HIGH VELOCITY OVER 350 FPS

16+

**For Ages 16 And Older
With Adult Supervision.**

! WARNING: NOT A TOY. ADULT SUPERVISION REQUIRED. MISUSE OR CARELESS USE MAY CAUSE SERIOUS INJURY OR DEATH. MAY BE DANGEROUS UP TO 259 YARDS (237 METERS).

THIS IS A HIGH POWER AIR GUN RECOMMENDED FOR USE BY THOSE 16 YEARS OF AGE OR OLDER. READ ALL INSTRUCTIONS BEFORE USING. THE PURCHASER AND USER SHOULD CONFORM TO ALL LAWS GOVERNING USE AND OWNERSHIP OF AIR GUNS.

ACCORDING TO CALIFORNIA LAW

! WARNING: DO NOT BRANDISH OR DISPLAY THIS AIRGUN IN PUBLIC - IT MAY CONFUSE PEOPLE AND MAY BE A CRIME. POLICE AND OTHERS MAY THINK THIS AIRGUN IS A FIREARM. DO NOT CHANGE THE COLORATION AND MARKINGS TO MAKE IT LOOK MORE LIKE A FIREARM. THAT IS DANGEROUS AND MAY BE A CRIME.



WARNING: THIS GUN CAN CAUSE DEATH. READ AND FOLLOW THE INSTRUCTIONS CAREFULLY. DO NOT LOAD A BB OR PELLET INTO THE CHAMBER UNTIL YOU ARE READY TO SHOOT. IF YOU DO LOAD A BB OR PELLET AND DECIDE NOT TO SHOOT, REMOVE EITHER MANUALLY OR BY SHOOTING IT IN A SAFE DIRECTION. AN UNCOCKED, UNLOADED GUN IS SAFEST. ACCIDENTS HAPPEN FAST, AND ACCIDENTALLY INJURING OR KILLING SOMEONE IS A TERRIBLE THING. SHOOT SAFELY.

POWERLINE® 880 / 880S / 1880

	BBs	PELLETS
MUZZLE VELOCITY (10 PUMPS)	750 fps - 229 mps	715 fps - 218 mps
SHOOTING DISTANCE (10 PUMPS)	291 yds. - 266 m	286 yds. - 261 m
MUZZLE VELOCITY CANADA (10 PUMPS)	490 fps - 149 mps	490 fps - 149 mps
SHOOTING DISTANCE CANADA (10 PUMPS)	247 yds. - 226 m	223 yds. - 204 m



This safety alert symbol indicates important safety messages in this manual. When you see this symbol, be alert to the possibility of personal injury and carefully read the message that follows.

This air gun shoots with much more power than the traditional spring air BB gun. More power means greater chance of serious injury or death.

We recommend the following number of pumps for different shooting conditions.

- For indoor shooting, 2 pumps
- For 10-meter (33-ft.) distance, 4 to 6 pumps.
- For longer distances, 7 to 10 pumps.

NOTE: Never pump more than 10 times. Over pumping will cause serious damage to the gun.

POWERLINE® 177X

	PELLETS
MUZZLE VELOCITY (10 PUMPS)	715 fps - 218 mps
SHOOTING DISTANCE (10 PUMPS)	286 yds. - 261 m
MUZZLE VELOCITY CANADA (10 PUMPS)	490 fps - 149 mps
SHOOTING DISTANCE CANADA (10 PUMPS)	223 yds. - 204 m

Although your new PowerLine® Air Rifle is not a firearm, it has lethal potential and should be treated with the caution and respect due any conventional firearm. Like a firearm, your PowerLine® Air Rifle, when misused or carelessly used, can kill or seriously injure the shooter or other persons.

Always remember, the first and most important safety aspect of any gun is the shooter. All safeties are mechanical devices and the shooter is the only part of the system that can make a gun safe—or unsafe. **DON'T DEPEND ON MECHANICAL SAFETIES;** think ahead and avoid situations that might lead to accidents.

Guns differ in their operations and you are never ready to fire any gun until you are thoroughly familiar with it. Read the following operating instructions and **WITHOUT LOADING A PROJECTILE**, proceed several times through the operating steps with your gun (dry fire the gun at a safe target) so that you will be able to operate the PowerLine® Air Rifle properly and safely.

POWERLINE® 22X / 22S / 22SG

	PELLETS
MUZZLE VELOCITY (10 PUMPS)	625 fps - 190 mps
SHOOTING DISTANCE (10 PUMPS)	333 yds. - 304 m
MUZZLE VELOCITY CANADA (10 PUMPS)	490 fps - 149 mps
SHOOTING DISTANCE CANADA (10 PUMPS)	257 yds. - 255 m

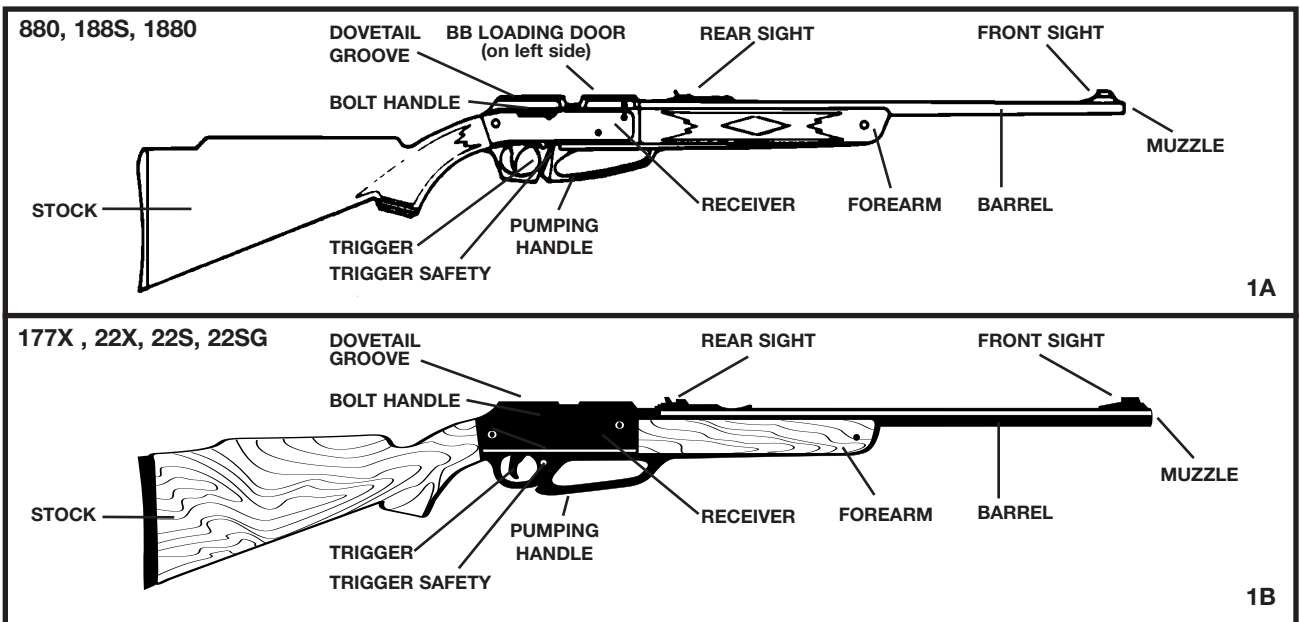

HOW TO OPERATE

CAUTION: Be sure gun is always pointed in a safe direction

- Step 1. OPEN BOLT
- Step 2. PUT "ON" TRIGGER SAFETY
- Step 3. PUMP
- Step 4. LOAD
- Step 5. CLOSE BOLT
- Step 6. AIM AT SAFE TARGET
- Step 7. TAKE "OFF" TRIGGER SAFETY
- Step 8. FIRE

Step 1. OPEN BOLT

Pull straight back on bolt handle, pulling it fully to the rear (See Drawing No. 1A). The gun cannot fire with bolt open.

Step 2. PUT "ON" TRIGGER SAFETY

The bolt must **FIRST** be opened, then the trigger safety is pushed from the left to right so that **NO** red is showing (See Drawing No. 1B).

CAUTION: Gun must always be pointed in a safe direction.

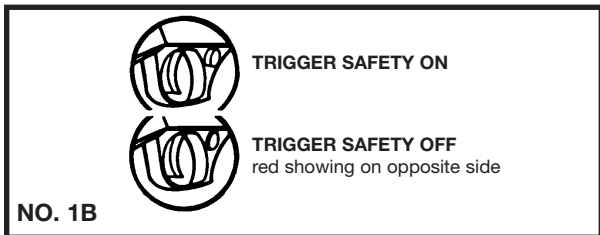
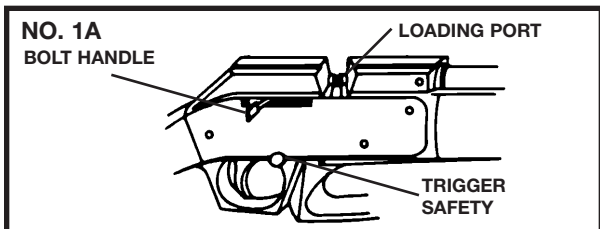

Step 3. PUMP

The bolt must be opened to pump gun. For greater safety, we recommend that the bolt remain open while pumping and that you close the bolt only when the barrel can be pointed in a safe direction. With the muzzle pointed in a safe direction, pump the gun the desired number of times up to 10. More power means greater chance of serious injury. Never put finger on trigger until ready to fire the gun. **NOTE:** Do not pump your gun more than 10 times. Muzzle energy increases produced by more than 10 pumps are minor, and increased pumping will damage your gun.

CAUTION: Be sure to grasp pump handle firmly as you close the lever to prevent it from snapping back and causing possible injury. Also be careful to keep fingers out of cocking mechanism when closing lever. (See "PINCH POINTS," Drawing No. 2).

WARNING: Do not open the bolt, close the bolt, and then pull the trigger before pumping. This procedure can result in a **loaded gun** and a projectile being expelled from the gun during pumping. Recock the gun by opening the bolt and put "on" trigger safety before pumping as in Steps 1 and 2.

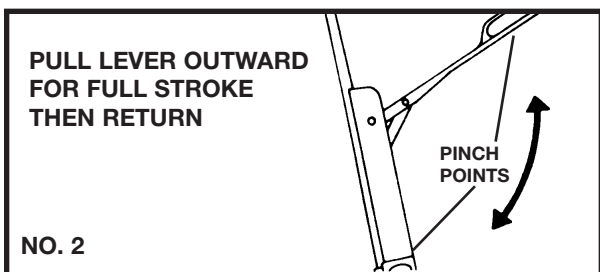

Filling the BB magazine for the PowerLine® 880, 880S, 1880:

The loading door is located on the left side of receiver (See Drawing No. 3). Push door down and fill magazine with approximately 50 BBs. Do not overfill or the feed system may not operate properly.

Step 4. LOAD (PowerLine® 880, 880S, 1880)

LOADING BBs: With the bolt handle back and BBs in the magazine (See "BB MAGAZINE" section), RAISE the muzzle of the gun 45 degrees to 90 degrees. When raising the muzzle, be sure the front sight is pointed upward since the gun may not feed properly if it is on its side (See Drawing No. 4A). A BB can be seen on the magnetic tip by looking into the loading port (See Drawing No. 4A). If a BB does not feed onto the magnetic tip when the muzzle is raised, shake the gun slightly. Push bolt handle fully forward and the BB is in firing position. Be sure the front sight is pointed upward when raising the muzzle to insure proper feeding.

CAUTION: Always view the BB or Pellet when closing the bolt and loading port.

WARNING: BBs feed from the magazine by gravity which requires that the muzzle be raised. **NEVER ASSUME THE MAGAZINE OR CHAMBER IS EMPTY** even if the gun does not fire a projectile.

LOADING PELLETS: With the bolt back and BBs removed from the magazine (See "TO EMPTY MAGAZINE," Page 7), advance the bolt forward until the magnetic tip is visibly even with the rear edge of the pellet loading port; lower the muzzle and load a pellet, solid end forward (See Drawing No. 5). Push the bolt handle fully forward and the pellet is chambered in the firing position.

IMPORTANT: Do not allow a pellet to fall into the rear of the loading port and become jammed in the BB feed hole. If this occurs, have a qualified gunsmith remove the left receiver and clear the loading port or return gun to Daisy.

IMPORTANT: Care must be exercised when shooting pellets while the magazine contains BBs. Loading a BB and pellet at the same time may result in a jammed or obstructed barrel.

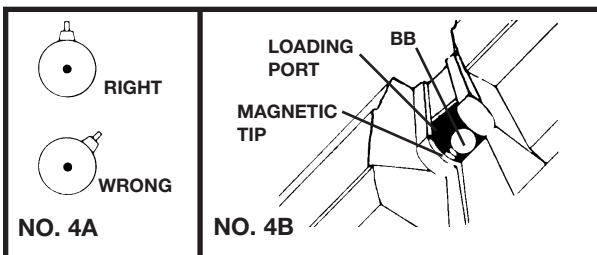
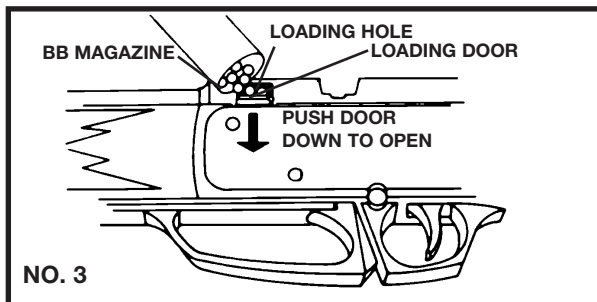

Step 4. LOAD (PowerLine® 22X, 22SGT, 22S)

LOADING PELLETS: With the bolt back lower the muzzle and load a pellet, solid end forward (See Drawing No. 5). Push the bolt handle fully forward and the pellet is chambered in the firing position.

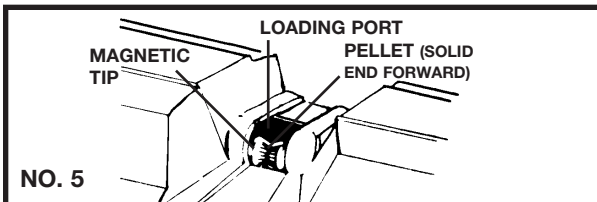

Step 5. CLOSE BOLT

Close bolt by pushing fully forward on bolt handle to chamber either a BB or pellet and lock the bolt.

CAUTION: The gun is now loaded and ready to fire.

Step 6. AIM AT SAFE TARGET

Aim the gun at a safe target. To be a consistent marksman, use the correct sight picture each time you fire your gun (See Drawing No. 6). **Never point a gun, loaded or unloaded, at anyone.**

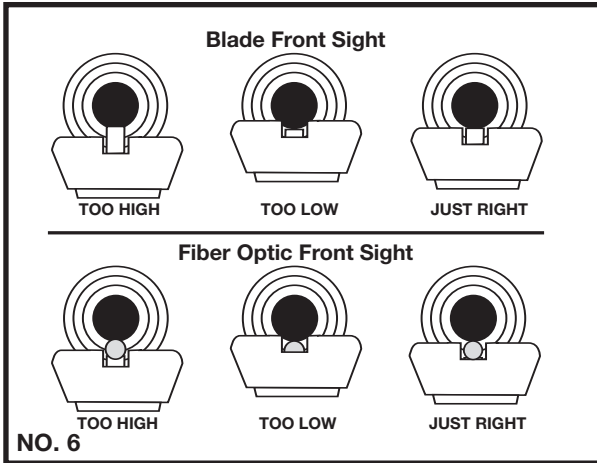

CAUTION: Due to the power of this air gun, use extra caution in selecting a safe target backstop. Select the proper target and backstop based on the ammunition you are shooting. BBs should NEVER be shot into a pellet trap. Pick targets that cannot be penetrated or that will not cause ricochet because of their hard surface. Use only targets and traps that are designed for use with high power air guns. Do not shoot at water.

Step 7. TAKE "OFF" TRIGGER SAFETY

When you are certain the target, backstop and surrounding area is safe, take trigger safety "OFF" by pushing from right to left so that red is exposed. Your gun is now cocked and ready to shoot. In this condition, it should be handled with extreme care.

Step 8. FIRE

After making sure the gun is pointed in a safe direction, gently (but firmly) squeeze the trigger. Repeat Steps 1 through 8 to continue shooting, using the appropriate loading procedure. **NOTE:** To fire, bolt must be completely closed as indicated in Step 5.

CAUTION: Do not leave your gun pumped for an extended period of time. This could result in a time delay from the time the trigger is pulled until the projectile is expelled from the gun. Also, leaving your gun pumped for more than one hour could result in permanent damage to the air release valve.

WARNING: If a BB or pellet does not fire after completing the operation steps, the gun is jammed. This is a dangerous condition.

CLEARING A JAM (POWERLINE® 880, 880S, 1880)

Open the bolt and put "ON" trigger safety immediately. If the bolt is not completely closed, do not try to close it until after opening it by pulling the bolt handle all the way back. The gun will not fire a projectile when the bolt is completely open.

Repeat all operations except Step 4 (do not load BB or pellet), pumping gun up 10 times. If a projectile still does not fire, follow these steps carefully:

1. Open bolt.
2. Put trigger safety "ON".
3. Clear barrel by running a cleaning rod through from the muzzle end. Be careful not to damage the bolt tip by pushing the rod through too hard. Do not reuse this BB or pellet.

4. Repeat operation steps. Make sure a BB or pellet is fed into firing position. If after following the firing procedure the projectile is not fired, return your gun to Daisy (See "REPAIR OF DAISY GUNS" section).

UNLOAD PELLETS: The magnetic tip does not extract a pellet. You must shoot the pellet out if a safe target is available. If a safe target is not available, open bolt, put trigger safety "ON", insert a cleaning rod in the muzzle end and push the pellet out of the barrel. Do not allow a pellet to fall into the rear of the loading port and become jammed in the BB feed hole.

TO EMPTY BB MAGAZINE:

Open bolt and put trigger safety "ON". Open the BB magazine door, cup your hand over it and tilt the gun fully to the left side. Shake gun until all BBs are removed. Then remove BBs from loading port (See Drawing No. 4B).

WARNING: EVEN IF YOU HAVE FIRED THE AIRGUN ONE OR MORE TIMES AND NO BB WAS EXPELLED, IT DOES NOT MEAN THAT THE GUN IS EMPTY OF BBs. CONTINUE TO TREAT THE AIRGUN AS IF IT IS LOADED.

CLEARING A JAM (POWERLINE® 22X, 22SG, 22S)

Open the bolt and put "ON" trigger safety immediately. If the bolt is not completely closed, do not try to close it until after opening it by pulling the bolt handle all the way back. The gun will not fire a projectile when the bolt is completely open.

Repeat all operations except Step 4 (do not load a pellet), pumping gun up 10 times. If a projectile still does not fire, follow these steps carefully:

1. Open bolt.
2. Put trigger safety "ON".
3. Clear barrel by running a cleaning rod through from the muzzle end. Be careful not to damage the bolt tip by pushing the rod through too hard. Do not reuse this pellet.
4. Repeat operation steps. Make sure a pellet is fed into firing position. If after following the firing procedure the projectile is not fired, return your gun to Daisy (See "REPAIR OF DAISY GUNS" section).

UNLOAD PELLETS: The bolt tip does not extract a pellet. You must shoot the pellet out if a safe target is available. If a safe target is not available, open bolt, put trigger safety "ON", insert a cleaning rod in the muzzle end and push the pellet out of the barrel.

WARNING: Never assume gun is empty of projectiles. Always point the gun in a safe direction.

REAR SIGHT ADJUSTMENT:

Your air gun is equipped with an adjustable rear sight.

HOW TO ADJUST SIGHT RIGHT OR LEFT (WINDAGE):

Loosen screw "A" by turning counterclockwise (See Drawing No. 7). Move rear sight to the right side of the gun to make it shoot to the right, or to the left side of the gun to make the gun shoot to the left. Make certain screw "A" is retightened after adjustment.

HOW TO ADJUST SIGHT UP OR DOWN (ELEVATION):

Raise the rear sight by moving sight elevator back to make the gun shoot higher. Lower the rear sight by moving the sight elevator forward to make the gun shoot lower (See Drawing No. 8).

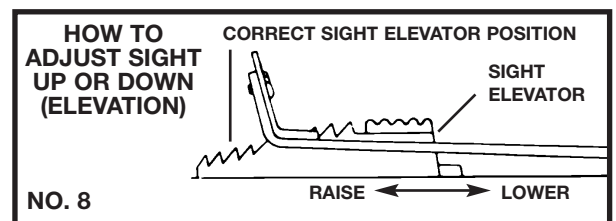
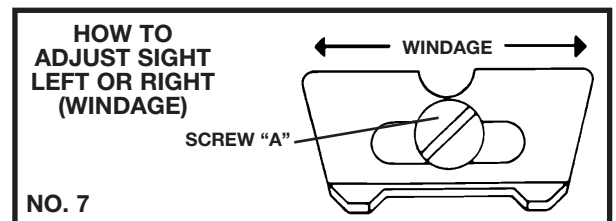

PROPER CARE

To maintain top shooting performance, lightly oil the three pumping lever hinges and the foam wiper on the piston every 1,000 shots (See Drawing No. 9). Use a 10-, 20- or 30-weight non-detergent, automotive motor oil. **DO NOT** use light, household type oils or aerosol type spray lubricants since they may contain substances or additives harmful to the rubber seals or other components. Clean the exterior by wiping with a soft, clean, lightly oiled cloth. The screws are a gun blue finish; wipe with oil to prevent rust.

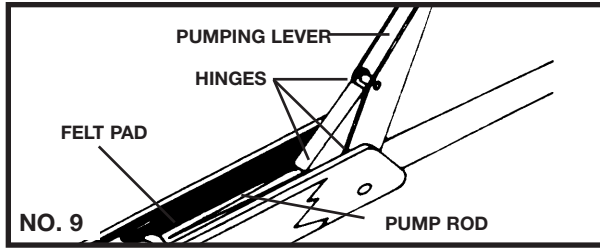

CAUTION: Improper lubricants, such as aerosol type spray lubricants, can ignite (diesel) during pumping. Use only automotive motor oils.

STORAGE

Before putting the gun away in a cabinet or gun rack, shoot the gun at a safe target to make sure the pump system and barrel are empty. Then, open the bolt and place the trigger safety "ON", then close the bolt. Always make sure the gun is empty and the trigger safety is "ON" before storage; the gun should also be clean, dry and oiled.

Store projectiles in a separate location from the gun to keep it away from untrained shooters.

WARNING: EVEN IF YOU HAVE FIRED THE AIRGUN ONE OR MORE TIMES AND NO BB OR PELLET WAS EXPULSED, IT DOES NOT MEAN THAT THE GUN IS EMPTY OF AMMO. CONTINUE TO TREAT THE AIRGUN AS IF IT IS LOADED.

MODIFICATION

WARNING: The components of this gun were engineered to deliver optimum performance. Any modification or tampering with a gun may cause a malfunction and may make it unsafe to use. Any change in performance, such as a lowered trigger force and shortened trigger travel, indicates possible wear, and such gun should be inspected, replaced or properly repaired by qualified personnel. Any gun that has been dropped should be checked by qualified personnel to insure that its function has not been effected.

WARNING: A GUN THAT IS NOT OPERATING PROPERLY MAY BE DANGEROUS. IT SHOULD BE KEPT SAFELY FROM USE BY ANYONE UNTIL REPAIRED OR DESTROYED. DO NOT TRY TO TAKE THE GUN APART. IT IS DIFFICULT TO REASSEMBLE, AND IMPROPER REASSEMBLY CAN CAUSE A HAZARDOUS CONDITION.

**GUNS IN WARRANTY
LIMITED ONE – YEAR WARRANTY**

For one year from date of purchase, Daisy will repair or replace this gun, free of charge, if defective in material or workmanship. Service is available by returning the gun to Daisy Outdoor Products. Attach to the gun your name and address and telephone number, description of problem and proof of date of retail purchase (sales slip). Package and send to Daisy Outdoor Products, transportation prepaid. This Warranty gives you specific legal rights, and you may also have other rights which may vary from state to state.

GUNS OUT OF WARRANTY

If your Daisy needs repair, call Customer Service at 1-800-713-2479 for repair or replacement charge. We accept Visa and Mastercard. When paying by check or money order, please send with gun. Attach to the gun your name, street address (Not Post Office Boxes) and description of the problem. Package and send, transportation prepaid, to Daisy Outdoor Products, Service Department. Daisy will repair the gun or replace it with a reconditioned gun of the same model, if available, otherwise with a model of equivalent quality.

Exploded gun part drawings and price lists are available from Daisy Service Department. Please make sure you state model number stamped on barrel. Service and parts charges are subject to change without notice. Daisy Outdoor Products, Service Department, 308 West Stribling Drive, Rogers, AR 72756 U.S.A.

NOTE: We recommend returning guns via UPS.

SPECIFICATIONS: 880, 880S, 1880

ACTION	Multi-pump pneumatic pump-up BB repeater; single shot pellet
CALIBER	.177 cal. (4.5mm)
AMMO CAPACITY	50-shot BB; single-shot pellet
OVERALL LENGTH	37.75 in. (95.8cm)
WEIGHT	3.2 lbs. (1.45 kg)
TARGET DISTANCE	33ft (10m)
MAXIMUM SHOOTING DISTANCE**(CANADA)	BB: 247 yds. (226m)* Pellet: 223yds. (204m)*
MAXIMUM SHOOTING DISTANCE**	BB: 291 yds. (266m)* Pellet: 286yds. (262m)*
BARREL	20.8in. (53cm) rifled steel barrel
SAFETY	Manual cross bolt trigger block with red indicator

*Indicates 10 pumps

**With muzzle pointed upward at optimum angle

SPECIFICATIONS: 177X, 22X, 22SG, 22S

ACTION	Multi-pump pneumatic pump-up single shot pellet
CALIBER	177X - .177 cal. (4.5mm) 22X, 22SG, 22S - .22 cal. (5.5mm)
AMMO CAPACITY	Single-shot air gun pellet
OVERALL LENGTH	37.75 in. (95.8cm)
WEIGHT	3.2 lbs. (1.45 kg) - 4.5 lbs. (2.04 kg) Depending on Model
TARGET DISTANCE	33ft (10m)
MAXIMUM SHOOTING DISTANCE**(CANADA)	177X - 223 yds. (204 m)* 22X, 22SG, 22S - 257 yds. (255 m)
MAXIMUM SHOOTING DISTANCE**	177X - 286 yds. (262 m)* 22X, 22SG, 22S - 333 yds. (304 m)
BARREL	20.8in. (53cm) rifled steel barrel
SAFETY	Manual cross bolt trigger block with red indicator

*Indicates 10 pumps

**With muzzle pointed upward at optimum angle



INTRODUCING POWERLINE[®] SHOOTING

A MESSAGE TO PARENTS

Included in the material accompanying each new PowerLine® is a check list covering the most important aspects of proper gun handling. We urge you to use the check list in assuring that anyone operating a PowerLine® has a thorough understanding of these rules and is diligent in their practice. Although not a firearm, a PowerLine® is a gun and not a toy. Properly used and maintained, it will provide many hours of safe, trouble free recreational shooting. **Misused, it can be dangerous. Therefore, we recommend it be used only by someone sixteen years of age or older and with adult supervision.**

As the proud owner of a new PowerLine® gun, you have become part of an American tradition dating back more than 100 years. Mechanically, a new PowerLine® is backed by nearly a century of engineering know-how and experience in the manufacture of quality products.

Safe gun handling depends upon proper safety training and the right attitude toward gun ownership. To help you, we have designed this booklet to cover the basic facts everyone should understand before shooting a gun. Take time to study it thoroughly. A proper understanding of these basics will greatly increase your enjoyment of the lifetime sport of recreational air gun shooting and, at the same time, give you the satisfaction of knowing you are properly prepared to handle an air gun.

If your child becomes the owner of a PowerLine® gun, we strongly urge a formal course of instruction in Shooting Education for your child. Daisy products are age graded to help you pick the right product for your child. There are a number of youth and civic organizations which offer a complete 10 lesson course based on guidelines developed by the training experts at Daisy and they are listed in the section of CLUBS AND COMPETITION near the back of this book. A quick check with them will let you know when the next course will be starting in your area. If you would like more detailed information, write: Special Market Programs, Daisy, Box 220, Rogers, Arkansas 72757 or call 1-800-643-3458.

WHAT IS A POWERLINE®?

Backed by 100 years of engineering know-how, the design and craftsmanship of the PowerLine® rifles and pistols has advanced to true gun levels. With much more power than traditional air guns, their sophistication in performance and operation have brought them to the attention of even the most serious sport shooters.

In recent years, sport shooters have begun to feel the squeeze of limited space and money for firearm shooting. The PowerLine® guns remove these limits for both the enthusiast who wants low cost shooting for year-round training, indoors or out, and dedicated shooters interested in shoulder-to-shoulder competition. With a PowerLine® gun, looks, heft and performance add up to adult size shooting right at your doorstep, and at a fraction of the cost of firearm shooting.

PROPER GUN HANDLING

You may be familiar with the responsibilities of proper gun handling, but the fact that your new PowerLine® gun has much more power than a traditional air gun means extra care is needed. In reviewing the basic rules of proper gun handling, keep in mind that "Handling" means every time you touch your gun.

- **Always keep the muzzle pointed in a safe direction.**
- **Treat every gun as if it were loaded**
- **Only load or cock a gun when you are shooting**
- **Anyone shooting or near a shooter should wear shooting glasses and should be standing behind the shooter.**
- **Never climb or jump with a gun.**
- **Avoid ricochet.**
- **Keep the muzzle clear.**
- **Guns not in use should always be unloaded.**
- **Respect other people's property.**
- **Check your target and beyond your target.**

Almost all of the air gun related accidents occurring in this country are caused by careless use or misuse of the gun and shooting at improper targets. These incidents can be eliminated if the shooter handles the gun properly.

YOUR POWERLINE® IS A TARGET GUN

Your PowerLine® gun has been designed for target shooting and is suited for use both indoors and out to help you develop your marksmanship skills. However, your PowerLine® gun means greatly increased velocity and energy, so take care to prepare your target. Target traps designed for use with low-velocity (less than 350 feet-per-second) spring-piston BB and pellet guns **should not be used with a PowerLine® gun.** Always use a target trap designed to prevent ricochet and put extra reinforcement behind your target to compensate for the added power. (See "How to Make an Indoor-Outdoor Target," page 14).

TIPS ON MARKSMANSHIP

Many people become proficient at gun handling without learning the basics of proper marksmanship. Yet, these basics are intended for one purpose—to increase your skills. If you haven't learned them, now is the time to start. If you have, this may serve as a timely review.

Although there are four basic positions for shooting - prone, sitting, kneeling, and standing, the one most challenging and the one you will undoubtedly use most often is standing. To assume the proper position, follow these simple rules: (All directions have been given for right hand shooters - left hand shooters should, of course, reverse the procedure.)

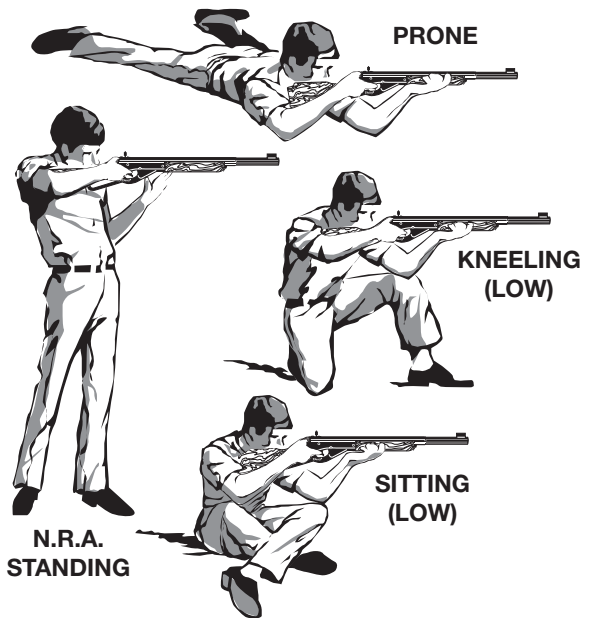

STANDING

- From a position directly facing the target, face to the right of the line of fire. The knees should be straight but not locked.
- Grasp the forearm of the gun in the left hand and place the butt of your gun in the shoulder pocket with the muzzle pointed upward.
- With the right hand, grasp the stock at the pistol grip, then press your cheek gently against the stock as far forward as possible without straining.
- Thrust the left hip forward, lower the gun to shoulder height, and with the left elbow directly under the gun, let the left upper arm rest against your body.
- The forearm of the gun should be supported in the palm of the left hand. (Thumb and fingertips, if using the NRA standing position.)
- Shift your weight to the left foot and lean your upper body away from the target.

To assume the other positions: (It should be noted again that left hand shooters reverse these directions when assuming the following positions).

PRONE

- Half face to the right, then lie at an angle of about 45 degrees to the line of fire. The left leg should be completely relaxed. The right leg should angle away from the spine and may be bent or straight. The feet should be as flat on the ground as possible.

SITTING

- Half face to the right, then in the low position, cross your legs in front of you with the outside of each foot resting on the ground and supporting the knees. Elbows should be placed near the knees, forming triangles to support the rifle.
- In the high position, legs are not crossed; the feet are well spread, with the heels braced, and the body leaning forward so the elbows may be braced by the knees.

KNEELING

- Half face to the right and drop to the right knee. In the low position, the left foot should be extended as far forward as is comfortable while the right leg is flat on the ground with the shooter sitting on the side of his foot. In the high position, the shooter sits on his right heel.

SIGHTING-IN YOUR GUN

The first step in proper sight alignment is to determine the shot grouping of your new air-gun. To do this, position a rest, such as a table or bench, 33 feet from your target. Place your rifle on the rest and aiming at the same point on the target each time, fire three shots. Do not attempt to make any adjustments during the three shots. At this point you are only interested in how well your shots group. Once you have determined the grouping ability of you and your rifle, you can then adjust your sights to bring the group on target. **NOTE:** It may be necessary for each person shooting your airgun to realign the sights to fit his sight pattern.

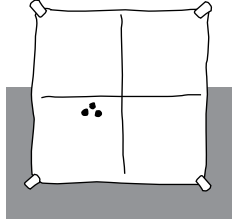

HOW TO MAKE AN INDOOR-OUTDOOR TARGET

Because of the velocity and energy of PowerLine® air-guns, care must be exercised in assuring that you have an adequate backstop for your target. A cardboard box 16 inches or more deep, and with at least two-foot square front surface, will serve as the basis for the target. Center 3 inches of tightly bound magazines (do not substitute newspapers) on the inside back wall of the box opposite the target, and fill the box with tightly packed, crumpled newspaper to prevent ricochet. Once the backstop is complete, tape the target to the front of the box. **Do not use metal fasteners—ammunition can ricochet.** As the target is used, the backing must be watched closely and should be replaced when the ammunition has penetrated half the thickness of the magazines.

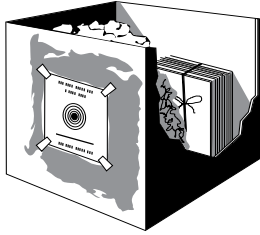

CAUTION: Whether you purchase a target trap or make your own, it is important to remember that **they will wear out** with continued use. Because of this, you should always place your backstop where it will be safe should it fail and check it carefully before and after each use. A rebound or ricochet is an indication that the backstop is faulty and that you should stop using it immediately.

INDOOR SHOOTING

Inside as well as out, the rules of proper gun handling remain the same. If these rules are observed, your PowerLine® is safe for indoor shooting. Just remember to take the gun's power into account and carefully follow the instructions for constructing the target backstop.

If you are using a multi-pump PowerLine® pneumatic air gun, two pumps are recommended for indoor shooting. This will give you a velocity only slightly higher than the conventional spring-piston gun. However, the PowerLine® CO2 guns, the high performance spring-piston guns and the single pump pneumatic airguns deliver consistent maximum power, so make certain that the target backstop has been properly built.

For safety reasons, you must have the target placed so that there are not entry ways in front of or to the side of the firing line or behind the targets. If this is not possible, then

doorways in the area should be blocked. A canvas or heavy blanket should be hung behind the target backstop which is free from the wall and clears the floor. This will prevent ricochet should you miss the backstop. Finally, your target should be well lighted.

Remember to keep your PowerLine® unloaded until the target is up and you are ready to shoot. **Never** point in any direction except down range.

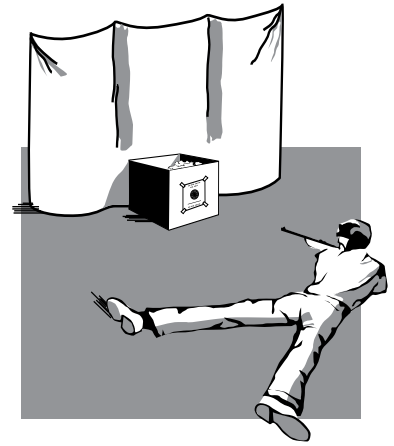

OUTDOOR SHOOTING

While your air gun is excellent for outdoor shooting, its exceptional power means extra care is needed. The target backstop described on the preceding page will work equally well for outdoor shooting where space is limited. Be sure the target area is clear and safe before shooting.

USE THE RIGHT AMMUNITION

PowerLine® guns are designed to use various types of ammunition. Some models shoot BBs only, while others shoot pellets only, and some shoot either BBs or pellets. Make certain you check the instructions stamped on your PowerLine® gun to assure that you use only the correct ammunition. The PowerLine® 901 shoots .177 caliber BBs and pellets. If improper ammunition is used, your gun will not feed correctly and may jam, possibly resulting in serious injury. Because dirty and misshapen ammunition can jam your gun, **DO NOT** reuse BBs or pellets.

LEARN TO SHOOT SAFELY

Daisy Outdoor Products has a rich heritage of teaching young and first time shooters to shoot safely. In order to effectively implement shooting education programs nationwide, Daisy has partnered with the following organizations which teach shooting safety and provide additional shooting safety materials and information. We encourage you to contact Daisy at 1-800-643-3458 or one of these organizations to sign up for a shooting safety class in your area.

PROGRAM MATERIALS & EQUIPMENT

Daisy Outdoor Products
800-713-2479
www.daisy.com

PROGRAM INFORMATION

American Legion Junior Shooting Sports Program
317-630-1249
www.legion.org

NRA Youth Programs
800-672-3888 ext. 1505
www.nrahq.org/youth

Daisy / Jaycees Shooting Education Program
The United States Junior Chamber of Commerce
800-529-2337
www.usjaycees.org

4-H Shooting Sports
Contact your County Extension Agent
www.4-h.org

Junior Olympic Shooting Program
719-866-4670
www.usashooting.com