

SHARP, TIGHT AND PRICED JUST RIGHT!

ATHLON
RIDICULOUSLY GOOD OPTICS

TALOS G2 850Y



LASER RANGEFINDER
USER MANUAL &
CARE INSTRUCTIONS

RANGEFINDER ELEMENTS

- ① "Mode" Button
- ② "Ranging"/"Power" Button
- ③ Eyepiece
- ④ Battery Compartment
- ⑤ Laser Receiving Objective
- ⑥ Laser Emission Objective

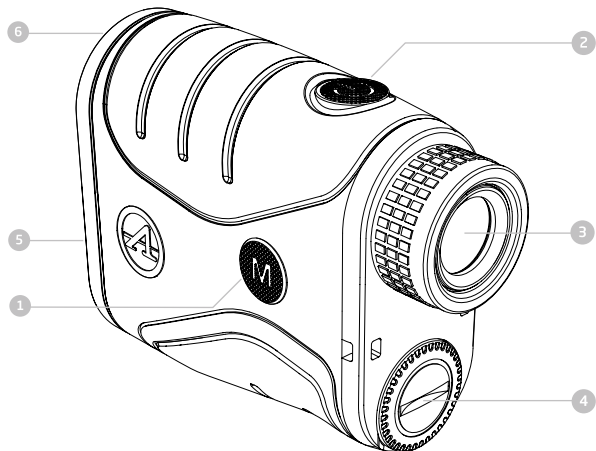

STARTUP AND SHUTDOWN

1. Remove the battery cap below the eyepiece and insert a CR2-3V battery into the battery chamber, having the positive side facing out, then close the battery cap.

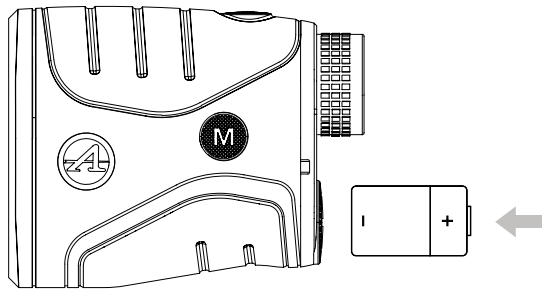

2. Short press  button to power the unit ON. You should see the startup display by looking through the eyepiece.
3. Laser Range Finder will automatically power off after idling for more than 10 seconds.

EYEPIECE LCD DISPLAY

- 1 Battery Indicator;
- 2 Aiming Reticle;
- 3 Golf Function Sign
- 4 Incline Angle, Horizontal Distance, Vertical Distance Mode Sign;
- 5 Distance and Auto function Display;
- 6 Incline Angle and Mode OFF;
- 7 Unit: M -- Meter, Y -- Yard.

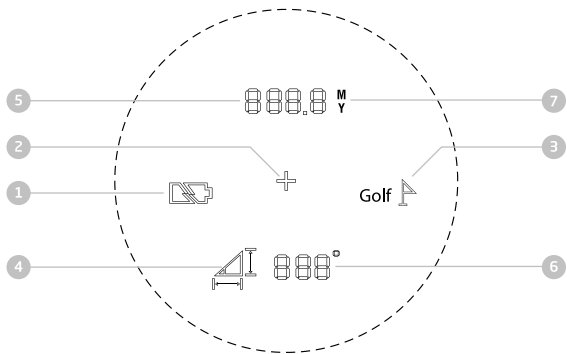

MENU OPERATIONAL FLOWCHART

1. **Power ON:** Short press  to power on. The startup screen will display the last used mode. After 10 seconds of no-operation the display will power off automatically.

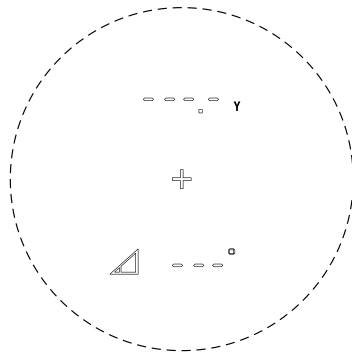

2. **Select display mode:** While the display is active, long press **M** button for more than 3 seconds. Press **⏻** button to select Golf or Auto mode. **Please choose Auto mode for hunting.** Flashing icon indicates selected.

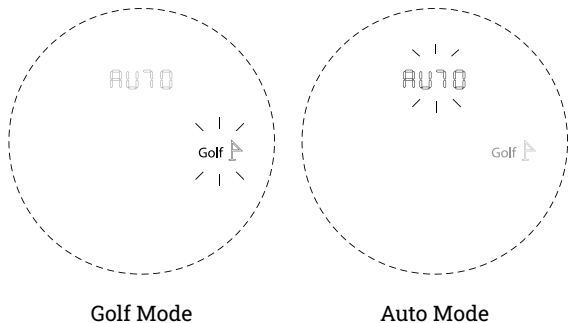

Short press **M** to confirm the item you selected. You will automatically enter into the line of sight / horizontal / angle selectable display.

3. **Select ranging mode:** Short press **⏻** to select one of the following ranging modes: Incline Angle, Vertical Distance, Horizontal Distance, "OFF" No-Display.

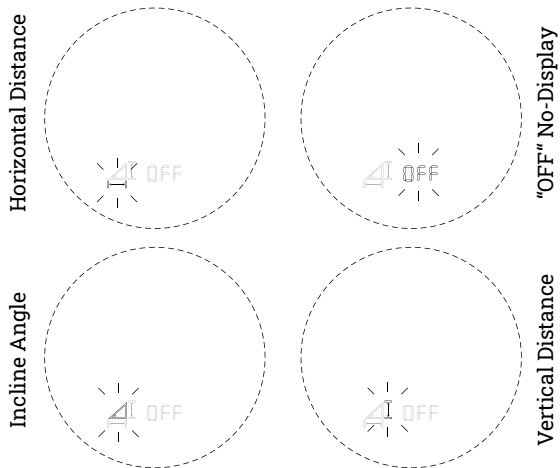

Short press **M** to confirm the item you selected. You will automatically enter the display for selecting Meter or Yard.

4. **Select measuring units:** Short press  to select "M" or "Y".

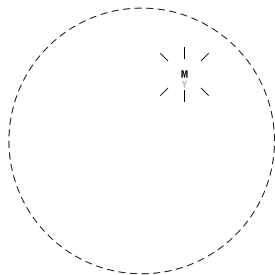

Meters

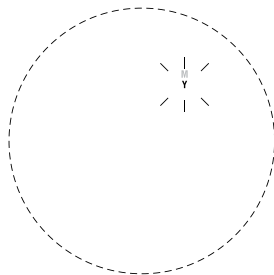

Yards

Short press  to confirm the unit of measurement you selected. You will automatically exit the setup mode and be ready for ranging.

5. **Low battery indication:** When the voltage is lower than 2.7V, "LOW BATTERY" sign will appear and blink as below, the blink interval is 1s, and will blink for 5 seconds and then power off automatically.

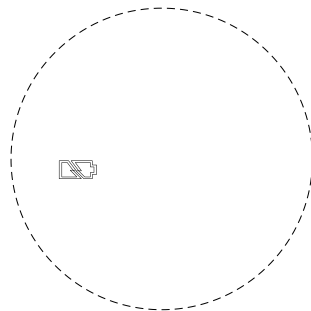

RANGING MODES TO CHOOSE FROM

Incline Angle mode displays the incline angle of your position to the target.

Horizontal Distance mode displays the angle compensated distance to the target. This is the primary mode used by most hunters (Both bow and rifle).

Vertical Distance mode displays the vertical distance of your position to the target.

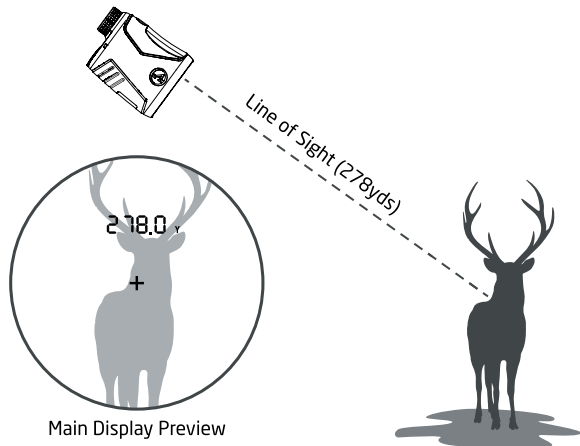

THE ATHLON GOLD MEDAL LIFETIME WARRANTY*

Your Athlon product is not only warranted to be free of defects in materials and workmanship for the lifetime of the product. Athlon will also repair or replace, at no charge to you, your product if you should damage it through normal use. No receipt is needed, no registration is required. This is a commitment that Athlon Optics will be the best product you can buy for your money.

****This warranty does not cover damages caused by deliberate damage, misuse, theft or maintenance provided by someone other than the Athlon Authorized Service Department.***



Toll free: 1-855-913-5678

contact@athlonoptics.com

801 N MEADOWBROOK DR,
OLATHE, KS 66062

ATHLONOPTICS.COM

SHARP, TIGHT AND PRICED JUST RIGHT!